

Cascade connection for time-invariant n -port networks

B. D. O. Anderson, and R. W. Newcomb

Synopsis

Questions concerning the existence of the scattering matrix for the interconnection of two networks are considered. It is shown that all interconnections can be regarded as a special type of interconnection termed cascade loading. If two networks in the cascade-loading configuration are separately linear, passive, time-invariant and have scattering matrixes, the same is true of the interconnection network. This result is applied to finite networks, and it is shown that any finite network composed of passive resistors, capacitors, inductors, gyrators and transformers has a scattering matrix. Some illustrative examples are also considered, pointing out that the results stated are the best obtainable.

1 Introduction

In the literature it seems well recognised that the scattering matrix is a useful and general description of networks and holds for a large class of networks.¹⁻³ Nevertheless, one can apparently find no proofs of statements to the effect that every linear passive time-invariant network has a scattering matrix.^{3,4} Indeed the nullator, defined by $V = I = 0$, which is a linear passive time-invariant network with no scattering matrix⁵ shows that the class of networks possessing scattering matrixes needs to be further delineated. Since it is known that a linear passive time-invariant network has a scattering matrix if, and only if, the network is solvable,⁵ we here investigate the preservation of the solvable property under various connections. In fact, all connections can be reduced to that of cascade loading, which we consequently investigate in some detail. The main important result of such a study, and hence the real justification for this work, is that any interconnection of positive resistors, inductors and capacitors, together with transformers and gyrators, possesses a scattering matrix, as is shown in theorem 2.

The paper consists essentially of four parts. Following a brief review in Section 2 of the definition and elementary properties of the scattering matrix, we introduce in Section 3 the concept of cascade loading. In effect, cascade loading is a means of viewing any connection so that one network appears as the load of another. Because of its ability to subsume arbitrary connections, some properties are studied in Section 4, where it is shown in theorem 1 that any cascade-loading connection of linear passive time-invariant and solvable networks always possesses a scattering matrix. However, the calculation of this scattering matrix is often subject to some delicate considerations, to which we therefore devote some space in Section 4. In Section 5 we consider finite networks in order to obtain theorem 2. Because finite networks can be considered in the cascade-loading form, their solvable nature is concluded in the demonstration of this theorem. The corollary generalises this result to connections of arbitrary passive solvable networks.

2 Preliminaries

Definitions appropriate to this paper may be found in References 5 and 6. We recall that the scattering matrix $S(p)$ of an n -port network maps incident voltages $V^i(p)$ into reflected voltages $V^r(p)$ through

$$V^r(p) = S(p)V^i(p) \quad (1)$$

The incident and reflected voltages are related to the port voltage V and current I n -vectors by

$$V^r = \frac{1}{2}(V - I) \quad (2a)$$

$$V^i = \frac{1}{2}(V + I) \quad (2b)$$

Unless otherwise stated we shall always assume that the network under consideration is passive, since we shall be primarily dealing with passive networks. For a passive n -port network N the existence of a scattering matrix is equivalent to N possessing the property of solvability,⁵⁻⁷ i.e. essentially the following equation must have a solution $I(p)$ for any given $E(p)$:

$$E(p) = V(p) + I(p) \quad (3)$$

Consequently, we shall use interchangeably the statements ' N has a scattering matrix' and ' N is solvable'.

When a network N is linear passive solvable and time-invariant, its scattering matrix $S(p)$ is termed bounded-real and satisfies the following conditions:⁶

- (a) $S(p)$ is analytic in the right halfplane $\text{Re}(p) > 0$
- (b) $S^*(p) = S(p^*)$ in $\text{Re}(p) > 0$ and almost everywhere on the $j\omega$ axis;
- (c) The matrix $\mathbf{1}_n - \tilde{S}^*(p)S(p)$ is a positive semidefinite hermitian matrix in $\text{Re}(p) > 0$ and almost everywhere on the $j\omega$ axis.

Here the superscript asterisk denotes complex conjugation, the superscript tilde denotes matrix transposition and $\mathbf{1}_n$ denotes the $n \times n$ identity matrix. The third condition essentially reflects the passivity of N ; it also implies⁸ that $\mathbf{1}_n - S(p)\tilde{S}^*(p)$ is a positive semidefinite hermitian matrix in $\text{Re}(p) > 0$.

3 Cascade loading

In this Section we define the concept of cascade loading and indicate the constraints placed on the port variables of networks placed in the cascade-loading configuration.

We suppose N_Σ is an $(n+m)$ -port network and N_l an m -port network. As shown in Fig. 1, N_l cascade loads N_Σ when the m ports of N_l are connected directly to m -designated ports of N_Σ . If we partition the incident and reflected voltage $(n+m)$ vectors for N_Σ into $\tilde{V}^i = [\tilde{V}_1^i, \tilde{V}_2^i]$ and $\tilde{V}^r = [\tilde{V}_1^r, \tilde{V}_2^r]$ (where V_1^i, V_1^r are n -vectors and V_2^i, V_2^r are m -vectors) and denote the incident and reflected voltages for N_l by V_l^i and V_l^r , we see that the cascade loading places the following additional constraints on the allowed scattering variables:

$$V_2^i = V_l^i = S_l V_l^i \quad \text{and} \quad V_2^r = V_l^r \quad (4)$$

If desired, these equations may be taken as one definition of cascade loading when an axiomatic treatment is being pursued.⁹

Suppose that N_Σ and N_l have scattering matrixes Σ and S_l ,

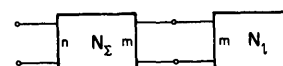

Fig. 1
Cascade-loading connection

PROC. IEE, Vol. 113, No. 6, JUNE 1966

Paper 5017 E, first received 23rd July and in revised form 21st December 1965
Prof. Anderson and Prof. Newcomb are with Stanford Electronics Laboratories, Stanford University, Stanford, Calif., USA

respectively, and that Σ is partitioned according to the port partition of N_Σ , so that we have

$$V_1^i = \Sigma_{11} V_1^i + \Sigma_{12} V_2^i \text{ and } V_2^i = \Sigma_{21} V_1^i + \Sigma_{22} V_2^i \quad (5)$$

The cascade-loading equations (eqns. 4) allow us to write

$$V_1^i = \Sigma_{11} V_1^i + \Sigma_{12} S_i V_1^i \quad (6a)$$

$$(\mathbf{1}_m - \Sigma_{22} S_i) V_1^i = \Sigma_{21} V_1^i \quad (6b)$$

The question whether the network N obtained by N_i cascade-loading N_Σ is solvable resolves itself into whether or not a given V_1^i determines a unique V_1^i . In eqns. 6a and b we see that V_1^i is related to V_1^i through an intermediate variable V_1^i . In Section 4, we shall consider the implications of this and establish conditions under which V_1^i determines V_1^i uniquely.

Although at first sight the class of interconnections which are described by cascade loading may appear to be fairly restricted, this is not the case. Indeed, as illustrated in Fig. 2, any connection of two multiports N_1 and N_2 can be interpreted in cascade-loading form by isolating the interconnecting leads. In Fig. 2 N_1 and N_2 can alternatively be considered as comprising a load N_i on an N_Σ consisting of only the connecting leads. The important cases of series, parallel and the normal cascade connections are detailed in Fig. 3. We comment that, as with all interconnections of n -port networks, the describing equations must remain valid for the subnetworks before and after connection.¹⁰

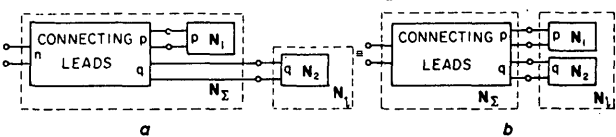

Fig. 2
Arbitrary connection as cascade loading, two viewpoints

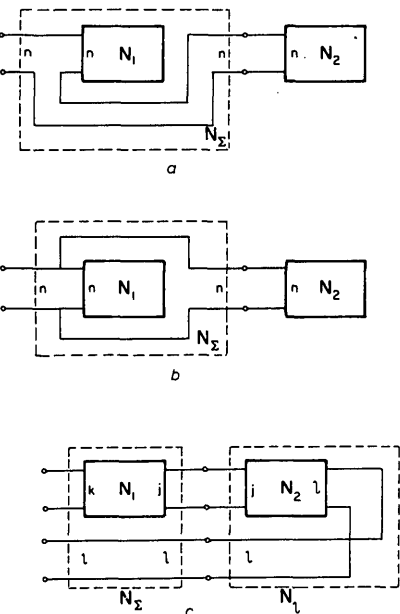

Fig. 3
Cascade-loading connections
a Series connection
b Parallel connection
c Cascade connection

4 Main theorem

In this Section we consider the solvability properties of cascade-loaded networks. We suppose that N_i and N_Σ are two solvable networks in the cascade-loading configuration described in Section 3. As also pointed out in section 3, the cascade-loading interconnection has a scattering matrix

PROC. IEE, Vol. 113, No. 6, JUNE 1966

if eqns. 6a and b have a unique solution V_1^i for any prescribed V_1^i .

If the matrix $\mathbf{1}_m - \Sigma_{22} S_i$ has an inverse, we have

$$V_1^i = \{\Sigma_{11} + \Sigma_{12} S_i (\mathbf{1}_m - \Sigma_{22} S_i)^{-1} \Sigma_{21}\} V_1^i$$

and thus the scattering matrix of the cascade loading S exists and is given by

$$S = \Sigma_{11} + \Sigma_{12} S_i (\mathbf{1}_m - \Sigma_{22} S_i)^{-1} \Sigma_{21} \quad (7a)$$

or, by alternate manipulations on eqns. 4 and 5,

$$S = \Sigma_{11} + \Sigma_{12} (\mathbf{1}_m - S_i \Sigma_{22})^{-1} S_i \Sigma_{21} \quad (7b)$$

The question arises whether S exists when the inverse in eqns. 7a and b does not exist. The answer to this is contained in the following theorem.

Theorem 1: Let the $(n + m)$ -port network N_Σ and the m -port network N_i be linear passive time-invariant and solvable. The resultant cascade-connected network N is therefore also linear passive time-invariant and solvable, i.e. S exists.

We comment that the linearity, passivity and time-invariance follow immediately. For the proof of solvability we shall first require a lemma. Note that, in demonstrating solvability, it will be sufficient to demonstrate that an $S(p)$ is defined which is analytic in the right halfplane and satisfies $S^*(p) = S(p^*)$ there and almost everywhere on the $j\omega$ axis. The positive semidefinite character of $\mathbf{1}_n - S^*(p)S(p)$ automatically follows from passivity.

Lemma: In order to prove the desired theorem, it is sufficient to consider the case where $S_i = \mathbf{1}_m$.

Proof: If S_1 and S_2 are any two bounded-real scattering matrixes, then $S_1 S_2$ is also a bounded real scattering matrix.⁸ Consequently, $\hat{\Sigma}$ is a passive scattering matrix where

$$\hat{\Sigma} = \begin{bmatrix} \Sigma_{11} & \Sigma_{12} \\ \Sigma_{21} & \Sigma_{22} \end{bmatrix} \begin{bmatrix} \mathbf{1}_n & \mathbf{0} \\ \mathbf{0} & S_i \end{bmatrix} = \begin{bmatrix} \Sigma_{11} & \Sigma_{12} S_i \\ \Sigma_{21} & \Sigma_{22} S_i \end{bmatrix}$$

The situation of $\hat{\Sigma}$ loaded in m open circuits (i.e. $S_i = \mathbf{1}_m$) is then identical to the situation of Σ loaded in S_i . This proves the lemma.

Proof of Theorem: Since we can consider the case of the loading network consisting of m open circuits, it follows that we can consider the case of the loading network consisting of one open circuit. For if N_Σ loaded in one open circuit yields a solvable $N_{\Sigma 1}$, we may load this network in one open circuit to yield a solvable $N_{\Sigma 2}$, and so on, until we load $N_{\Sigma m-1}$ in an open circuit to yield N_Σ loaded in m open circuits.

Consequently, we assume Σ is loaded, so that Σ_{11} is $n \times n$, Σ_{12} is $n \times 1$, Σ_{21} is $1 \times n$ and Σ_{22} is 1×1 . If $\mathbf{1}_1 - \Sigma_{22}$ is nonsingular, the scattering matrix of the cascade loading is $S = \Sigma_{11} + \Sigma_{12} (\mathbf{1}_1 - \Sigma_{22})^{-1} \Sigma_{21}$.

Now Σ_{22} is itself a bounded-real scattering matrix, since it is the scattering matrix of the network obtained by terminating the first n ports of N_Σ in unit resistors. Accordingly (Reference 6, corollary 7a), the determinant of $\mathbf{1}_1 - \Sigma_{22}$, or $\mathbf{1}_1 - \Sigma_{22}$ itself, is either singular or nonsingular throughout the right halfplane and almost everywhere on the $j\omega$ axis. Having dealt with the nonsingular case, let us assume that $\mathbf{1}_1 - \Sigma_{22}$ is singular, i.e. $\Sigma_{22} = \mathbf{1}$. Considering the matrixes $\mathbf{1}_{n+1} - \hat{\Sigma}^* \hat{\Sigma}$ and $\mathbf{1}_{n+1} - \hat{\Sigma} \hat{\Sigma}^*$, which are positive, semi-definite and hermitian in $\text{Re}(p) > 0$ and almost everywhere on the $j\omega$ axis (by the bounded-real property of Σ), we see that $\Sigma_{21} = \mathbf{0}$ and $\Sigma_{12} = \mathbf{0}$ in this same region. Consequently, there is no coupling between the first n ports and the $(n + 1)$ th port, and thus loading of the $(n + 1)$ th port does not affect the properties of the network as viewed at the first n ports. In this case $S = \Sigma_{11}$ exists. Hence the theorem is established.

The proof of the preceding theorem gives few clues to determining the network behaviour in the general case. Before considering some examples we shall indicate how, in

general, an incident voltage V_1^i on the cascade loading determines a reflected voltage V_1^r . Summarising the material to be presented next, V_1^i through the properties of the matrixes appearing in eqn. 6b determines a V_1^r which is not necessarily unique. When this V_1^i and V_1^r are substituted in eqn. 6b, V_1^i is obtained. It is shown that the resulting V_1^r is unique, despite the nonuniqueness of V_1^i .

Accordingly, let us first consider the equation $(\mathbf{1}_m - \Sigma_{22} S_l) V_1^i = \Sigma_{21} V_1^r$ or, as we have shown in the lemma, the equivalent equation

$$(\mathbf{1}_m - \hat{\Sigma}_{22}) V_1^i = \hat{\Sigma}_{21} V_1^r \quad \dots \quad (8)$$

For simplicity of notation the superscript $\hat{}$ will be dropped.

We define the range of a matrix Σ_{ij} , written $\mathcal{R}(\Sigma_{ij})$, as the set of vectors $\Sigma_{ij} X$, where X is an arbitrary vector. For later use, we define the nullspace of a matrix Σ_{ij} , written $\mathcal{N}(\Sigma_{ij})$, as the set of Y for which $\Sigma_{ij} Y$ is the zero vector. We then claim $\mathcal{R}(\Sigma_{21}) \subset \mathcal{R}(\mathbf{1}_m - \Sigma_{22})$. In other words, given a V_1^r we can select a V_1^i satisfying eqn. 8. To see this, let an element of $\mathcal{R}(\Sigma_{21})$ be $W = \Sigma_{21} V_1^r$. Since Σ_{22} is a scattering matrix, there exists a constant orthogonal matrix T , such that

$$\tilde{T} \Sigma_{22} T = \begin{bmatrix} \Sigma_{22r} & 0 \\ 0 & \mathbf{1}_{n-r} \end{bmatrix} \quad \dots \quad (9)$$

where $\mathbf{1}_r - \Sigma_{22r}$ is nonsingular in the right halfplane and almost everywhere on the $j\omega$ axis. The proof of this result, a method of computing T and a general discussion of its significance may be found in Reference 7. We then assert $\Sigma_{21} V_1^r = W = (\mathbf{1}_m - \Sigma_{22}) V_1^i$ where V_1^i is given by

$$V_1^i = T \begin{bmatrix} (\mathbf{1}_r - \Sigma_{22r})^{-1} (\mathbf{1}_r \parallel 0_{r, n-r}) \tilde{T} \Sigma_{21} V_1^r \\ 0 \end{bmatrix} \quad \dots \quad (10)$$

This can be verified by rewriting eqn. 8 as $\tilde{T}(\mathbf{1}_m - \Sigma_{22}) T \tilde{T} V_1^i = \tilde{T} \Sigma_{21} V_1^r = \tilde{T} W$, multiplying on the left by $[\mathbf{1}_r \parallel 0_{r, n-r}]$, which leaves the left unchanged, and then multiplying the upper left by the inverse of $\mathbf{1}_r - \Sigma_{22r}$.

Although this gives one V_1^i satisfying eqn. 6b there generally are others, and consequently we must consider whether or not a unique V_1^i is defined in $V_1^i = \Sigma_{11} V_1^r + \Sigma_{12} V_1^l$. In fact V_1^i is unique, for the reason that, as shown below, the nullspace of Σ_{12} contains the nullspace of $\mathbf{1}_m - \Sigma_{22}$, or in symbols $\mathcal{N}(\Sigma_{12}) \supset \mathcal{N}(\mathbf{1}_m - \Sigma_{22})$. That this guarantees the uniqueness of V_1^i is clear, for if there are two V_1^i satisfying eqn. 8, their difference is in $\mathcal{N}(\mathbf{1}_m - \Sigma_{22})$ and thus in $\mathcal{N}(\Sigma_{12})$. Consequently they determine the same $\Sigma_{12} V_1^i$ and V_1^r by eqn. 6b. To see that $\mathcal{N}(\Sigma_{12}) \supset \mathcal{N}(\mathbf{1}_m - \Sigma_{22})$ observe that, as Σ is bounded-real, everywhere in the right halfplane, and almost everywhere on the $j\omega$ axis, $\mathbf{1}_m - \Sigma_{22}^* \Sigma_{22} - \Sigma_{12}^* \Sigma_{12}$ is a positive semidefinite hermitian matrix (here the notation is as given in Section 2). Consequently if $X \in \mathcal{N}(\mathbf{1}_m - \Sigma_{22})$, $X = \Sigma_{22} X$ and so $X^* (\mathbf{1}_m - \Sigma_{22}^* \Sigma_{22}) X = 0$. Then $X^* \Sigma_{12}^* \Sigma_{12} X = 0$, and thus $\Sigma_{12} X = 0$, i.e. $X \in \mathcal{N}(\Sigma_{12})$.

We conclude this Section with several examples, chosen for the purposes of illustrating the application of the main theorem and showing that the various conditions on N_Σ and N_l are, in general, necessary if the cascade loading connection is indeed to have a scattering matrix.

Example 1: We consider the normal cascade situation of Fig. 3c where N_1 is a $(k+j)$ -port network of scattering matrix Σ' and N_2 a $(j+l)$ -port network of scattering matrix S_l . We shall find the scattering matrix of the interconnection, assuming any indicated inverses exist.

Let

$$\Sigma' = \begin{matrix} k\{ \\ j\{ \end{matrix} \begin{bmatrix} \Sigma'_{11} & \Sigma'_{12} \\ \Sigma'_{21} & \Sigma'_{22} \end{bmatrix}, S_l = \begin{matrix} j\{ \\ l\{ \end{matrix} \begin{bmatrix} S_{l11} & S_{l12} \\ S_{l21} & S_{l22} \end{bmatrix}$$

The network N_Σ of Fig. 3c has the scattering matrix

$$\Sigma = \begin{matrix} k\{ \\ l\{ \\ j\{ \\ l\{ \end{matrix} \begin{bmatrix} \Sigma'_{11} & 0 & \Sigma'_{12} & 0 \\ 0 & 0 & 0 & \mathbf{1}_l \\ \Sigma'_{21} & 0 & \Sigma'_{22} & 0 \\ 0 & \mathbf{1}_l & 0 & 0 \end{bmatrix}$$

and the scattering matrix of the $(n+l)$ -port network formed by the cascade loading is

$$S = \begin{bmatrix} \Sigma'_{11} & 0 \\ 0 & 0 \end{bmatrix} + \begin{bmatrix} \Sigma'_{12} & 0 \\ 0 & \mathbf{1}_l \end{bmatrix} S_l \begin{bmatrix} \mathbf{1}_{j+l} - \begin{bmatrix} \Sigma'_{22} S_{l11} & \Sigma'_{22} S_{l12} \\ 0 & 0 \end{bmatrix}^{-1} \begin{bmatrix} \Sigma'_{21} & 0 \\ 0 & \mathbf{1}_l \end{bmatrix} \end{matrix} \quad \dots \quad (11a)$$

which may be written

$$S = \begin{bmatrix} \Sigma'_{11} & 0 \\ 0 & 0 \end{bmatrix} + \begin{bmatrix} \Sigma'_{12} S_{l11} & \Sigma'_{12} S_{l12} \\ S_{l21} & S_{l22} \end{bmatrix} \begin{bmatrix} (\mathbf{1}_j - \Sigma'_{22} S_{l11})^{-1} & 0 \\ 0 & \mathbf{1}_l \end{bmatrix} \begin{bmatrix} \Sigma'_{21} & \Sigma'_{22} S_{l12} \\ 0 & \mathbf{1}_l \end{bmatrix} \quad (11b)$$

Example 2: If we consider the cascade loading of Fig. 4, where the 1:1 transformers ensure that the ports are ports, we find

$$S_l = \begin{bmatrix} 0 & \mathbf{1} \\ 0 & 0 \end{bmatrix}, \Sigma = \begin{bmatrix} \frac{1}{2} & 0 & \frac{1}{2} \\ \frac{1}{2} & 0 & 0 \\ 0 & 1 & 0 \end{bmatrix}$$

From eqn. 7, where we interpret the inverse through the process described under the theorem,

$$S = \frac{1}{2} + \begin{bmatrix} 0 & \mathbf{1} \\ 0 & 0 \end{bmatrix} \begin{bmatrix} 1 & 0 \\ 0 & 1 \end{bmatrix} \left\{ \begin{bmatrix} 1 & 0 \\ 0 & 1 \end{bmatrix} - \begin{bmatrix} 1 & 0 \\ 0 & 0 \end{bmatrix} \right\}^{-1} \begin{bmatrix} \frac{1}{2} \\ 0 \end{bmatrix} = \frac{1}{2} \quad (12)$$

This connection has

$$\hat{\Sigma} = \begin{bmatrix} \frac{1}{2} & 0 & \frac{1}{2} \\ \frac{1}{2} & 0 & 0 \\ 0 & 1 & 0 \end{bmatrix} \begin{bmatrix} 1 & 0 & 0 \\ 0 & 0 & 1 \\ 0 & 0 & 0 \end{bmatrix} = \begin{bmatrix} \frac{1}{2} & 0 & 0 \\ \frac{1}{2} & 0 & 0 \\ 0 & 0 & 1 \end{bmatrix} \quad \dots \quad (13)$$

which shows that, after the connection, port 3 is uncoupled from the input. However, no physically realisable transformation can be performed on S_l and Σ , so that, before the interconnection, the separate third ports are uncoupled in the two subnetworks. Or, put another way, the diagonalisation of eqn. 9 cannot be generally realised on both Σ and S_l , but only on the product $\hat{\Sigma}$ of eqn. 13. This is in contrast to the case where N_l consists only of gyrators.¹¹

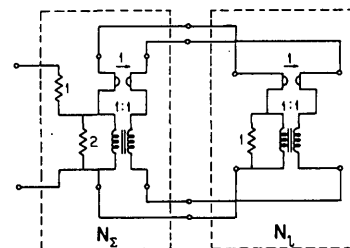

Fig. 4
Networks illustrating example 2

Example 3: The interconnection of active solvable networks need not be solvable, and the theory presented need not apply. Fig. 5 shows two networks, each of which individually has a scattering matrix. Moreover, the networks are, of course, linear and time-invariant; one is passive. The interconnection of the two networks does not, however, possess a scattering matrix.

Example 4: In Fig. 6 we show two networks interconnected which satisfy all but one of the conditions of the main theorem, namely that both networks be solvable. It may readily be seen that the interconnection is also not solvable.

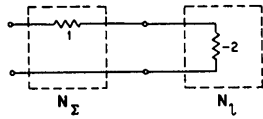

Fig. 5
A nonsolvable network (Example 3)

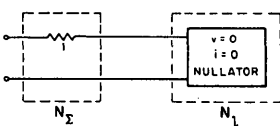

Fig. 6
A nonsolvable network (Example 4)

5 Finite networks

As pointed out in examples 3 and 4 of the preceding Section, in defining the circuit elements that may be used to form a finite network we must be careful to exclude such things as nullators and negative resistors. Except for the corollary, throughout this Section we shall implicitly assume that the networks contain circuit elements which are of the following types only: (a) positive-valued resistors, (b) positive-valued capacitors, (c) positive-valued inductors, (d) ideal transformers and (e) ideal gyrators.

Multiport transformers are included within the scope of these definitions. Belevitch¹² has defined such devices through the equations

$$V_1 = \tilde{T}V_2 \text{ and } I_2 = -TI_1 \quad \dots \quad (14)$$

where T is an $(m \times n)$ -turns-ratio matrix. The scattering matrix of such transformers exists and is given by⁵

$$S(p) = \begin{bmatrix} (1_n + \tilde{T}T)^{-1}(\tilde{T}T - 1_n) & 2(1_n + \tilde{T}T)^{-1}\tilde{T} \\ 2T(1_n + \tilde{T}T)^{-1} & (1_m + T\tilde{T})^{-1}(1_m - T\tilde{T}) \end{bmatrix} \quad \dots \quad (15)$$

Scattering matrixes clearly exist for gyrators, positive inductors, positive capacitors and positive resistors, and these matrixes do, of course, correspond to passive elements.

We then have the following result:

Theorem 2: Any time-invariant n -port network composed of a finite number of (passive) circuit elements possesses a scattering matrix $S(p)$.

Proof of Theorem: In brief, we represent a finite network as a cascade loading and prove that the constituent networks are solvable. The representation is easy, but the solvability proof is not trivial.

Any n -port network of the type stated can be redrawn as a cascade-loading connection of an $(n + p)$ -port network consisting entirely of short- and open-circuits loaded at its p ports by the various circuit elements of the network, each of the p ports being connected to only one element. This can be done so that, if the $(n + p)$ -port network were removed, the loading network would consist of a set of totally unconnected elements, as shown in Fig. 7. It follows that the scattering

PROC. IEE, Vol. 113, No. 6, JUNE 1966

matrix of the load network S_l exists, being the direct sum in the matrix sense of a number of single-network-element scattering matrixes. The load network is also, of course, linear passive and time-invariant.

The network N_Σ , consisting entirely of open- and short-circuits, is passive (in fact, lossless). We can conclude the result of the theorem if we can show that N_Σ possesses a scattering matrix, for then the cascade-loading theorem applies. Consider the augmented network corresponding to N_Σ shown in Fig. 8. The only network elements other than

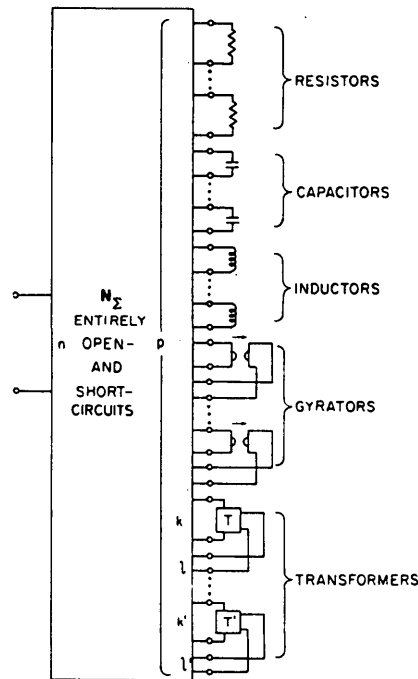

Fig. 7
Network for theorem 2

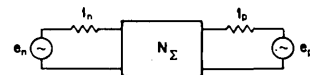

Fig. 8
Augmented network for theorem 2

voltage sources are the $p + n$ unit resistors. As is well known, we can form a tree for this network and select a certain set of corresponding link currents I_1 as independent; the remaining currents I_2 are then related to I_1 via a relation of the form¹³ $I_2 = BI_1$. We can arbitrarily choose reference directions for these branch currents to coincide with the reference directions for the port currents of N_Σ . Then I_1 and I_2 between them include all the port currents. Denoting the corresponding port voltages by V_1 and V_2 , the losslessness of N_Σ implies that $\tilde{V}_1I_1 + \tilde{V}_2I_2 = 0$ and thus, by $I_2 = BI_1$, $(\tilde{V}_1 + \tilde{V}_2B)I_1 = 0$. Since I_1 is arbitrary, it follows that $V_1 = -\tilde{B}V_2$. Comparing the results $V_1 = -\tilde{B}V_2$ and $I_2 = BI_1$ with eqn. 14, we see that the constraining relations on the port variables of N_Σ are the same as those for a transformer of turns ratio $T = -\tilde{B}$. Consequently, N_Σ is solvable. This proves the theorem.

Noting the last paragraph of the proof and observing Fig. 2b, we immediately have:

Corollary: Any interconnection of a finite number of linear passive time-invariant and solvable multiport networks results in a (linear passive time-invariant) solvable network.

6 Discussion and conclusions

Two principal results have been given in this paper. One concerns finite networks (theorem 2), giving a proof that

a network constructed from a finite number of common passive circuit elements does have a scattering matrix. The other result concerns the cascade-loading connection (theorem 1 and the corollary to theorem 2), giving conditions for the existence of the scattering matrix for passive interconnections. Although the cascade-loading connection is important as a natural description, being simply the loading of m ports of an $(n + m)$ -port network, it seems indispensable for general theoretical studies, since it can be used to describe arbitrary connections. This being the case, we have shown in Section 4 how the describing equations can be solved in the passive case. Of special interest is the fact that interconnecting leads can be isolated in the coupling network, N_{Σ} of Fig. 2b, to allow finite networks to be represented in the cascade-loading form of Fig. 7.

As a direct application of the material of this paper, it can be proved that Fig. 7 yields a reciprocal network when the gyrators are absent¹⁴ (by comparing eqn. 7 on transposing). As has been pointed out by Youla,¹⁵ the nullator cannot be constructed from a finite number of passive circuit elements. Theorem 2 provides another proof of this fact. When only the circuit elements of the types listed earlier are used, every passive time-invariant linear n -port network has a hybrid matrix description.^{16,17} Indeed, the hybrid matrix will exist only if the scattering matrix exists, and thus the theorems proved serve to delineate networks describable by hybrid matrixes.

The cascade-loading theorem does not hold without further restrictions for time-varying networks, where a simple counterexample is available.⁹ In the time-varying case the analogue of the range containment relation $\mathcal{R}[\Sigma_{21}] \subset \mathcal{R}[\mathbf{1}_m - \Sigma_{22}]$ does not always hold, but merely the corresponding relation for the closures of the spaces involved. Consequently, proofs are needed of the nature supplied here.

7 Acknowledgment

The authors wish to acknowledge the National Science Foundation under grants GP-520 and GK-237 for the

support of the research of this paper. One author (B. D. O. A.) would also like to acknowledge the financial support of the Services Canteens Trust Fund, an agency of the Australian Government, and the United States Educational Foundation in Australia for a Fulbright travelling grant. The expert assistance of Barbara Serrano in typing the manuscript is also gratefully acknowledged.

8 References

- 1 BELEVITCH, V.: 'Elementary applications of the scattering formalism in network design', *IRE Trans.* 1956, CT-3, p. 97
- 2 CARLIN, H. J.: 'The scattering matrix in network theory', *ibid.*, 1956, CT-3, p. 88
- 3 OONO, Y., and YASUURA, K.: 'Synthesis of finite passive $2n$ -terminal networks with prescribed scattering matrices', *Mem. Fac. Engng. Kyushu Univ.*, 1954, 14, p. 125
- 4 CARLIN, H. J., and GIORDANO, A. B.: 'Network theory' (Prentice-Hall, New Jersey, 1964)
- 5 NEWCOMB, R. W.: 'The foundations of network theory', *Instn. Engrs., Austral., Elect. Mech. Engng. Trans.*, 1964, EM-6, p. 7
- 6 YOULA, D. C., CASTRIOTA, L. J., and CARLIN, H. J.: 'Bounded real scattering matrices and the foundations of linear passive network theory', *IRE Trans.*, 1959, CT-6, p. 102
- 7 SPAULDING, D. A., and NEWCOMB, R. W.: 'The time-variable scattering matrix', *Proc. Inst. Elect. Electronics Engrs.*, 1965, 53, p. 651
- 8 BELEVITCH, V.: 'Factorization of scattering matrices with applications to passive-network, synthesis', *Philips Res. Rep.*, 1963, 18, (4), p. 275
- 9 ANDERSON, B. D., and NEWCOMB, R. W.: 'Functional analysis of linear passive networks', *Internat. J. Engng. Sci.*, 1966 (to be published)
- 10 GUILLEMIN, E. A.: 'Synthesis of passive networks' (Wiley, New York, 1957)
- 11 NEWCOMB, R. W.: 'A lower bound on the minimum number of gyrators in a passive network', Stanford Electronics Laboratories Technical Report 6554-8, 1964
- 12 BELEVITCH, V.: 'Theory of $2n$ -terminal networks with applications to conference telephony', *Elect. Commun.*, 1950, 29, p. 231
- 13 KIM, W. H., and CHIEN, R. T-W.: 'Topological analysis and synthesis of communication networks' (Columbia University Press, New York, 1962)
- 14 ANDERSON, B. D., and NEWCOMB, R. W.: 'On reciprocity in linear time-invariant networks', Stanford Electronics Laboratories Technical Report 6558-2, 1965
- 15 YOULA, D. C.: 'Internal structure of 1-ports simultaneously open and short-circuited', Polytechnic Institute of Brooklyn, Microwave Research Institute, Memorandum 47, 1961
- 16 ZUIDWEG, J. K.: 'Every passive time-invariant linear n -port has at least one 'H' matrix', *IEEE Trans.* 1965, CT-12, p. 131
- 17 ANDERSON, B. D., NEWCOMB, R. W., and ZUIDWEG, J. K.: 'On the existence of H matrices', *ibid.*, 1966, CT-13 (to be published)