

Homework 4
(Due: Friday, November 17, 2023)

Question 1: 10 points

The cantilever beam structure shown in Figure 1 carries a uniform load w (N/m) along its entire length.

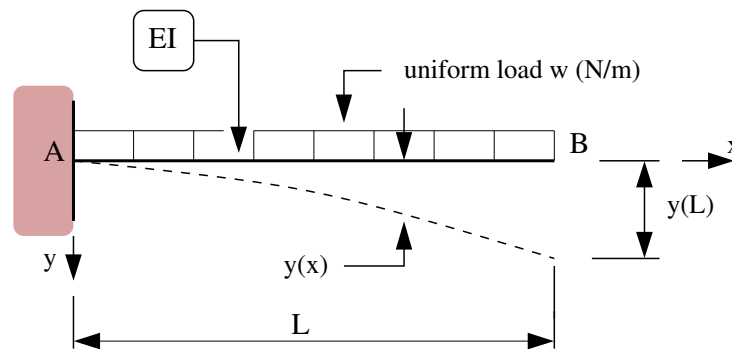

Figure 1: Cantilever beam carrying a uniform load.

The beam is fully fixed at point A and the flexural stiffness EI is constant along the beam. The coordinate system is positioned at point A.

[1a] (5 pts) Starting from the differential equation,

$$\frac{d^2y}{dx^2} = \left[\frac{M(x)}{EI} \right], \quad (1)$$

and appropriate boundary conditions, show that:

$$y(x) = \left(\frac{w}{24EI} \right) (6L^2x^2 - 4Lx^3 + x^4). \quad (2)$$

[1b] (5 pts) Using the results of question [1a] as a starting point, compute the support reactions at A and B for the propped cantilever shown in Figure 2

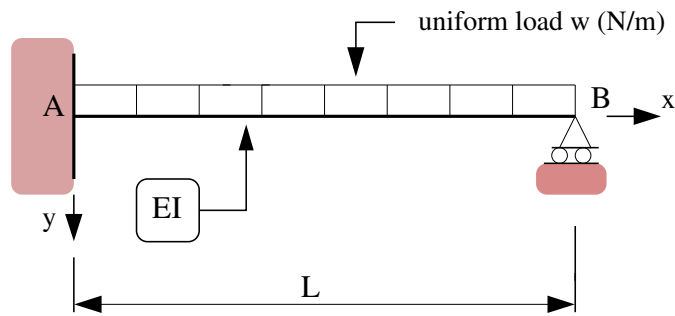

Figure 2: Propped cantilever beam carrying a uniform load.

Question 2: 20 points

Consider the cantilever shown in Figure 3.

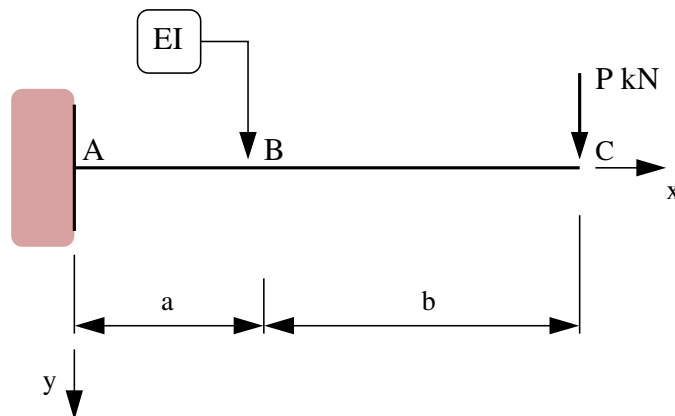

Figure 3: Front elevation view of a cantilever.

The cantilever has constant section properties, EI , along its entire length $(a+b)$. A vertical load P (kN) is applied at point C.

[2a] (3 pts) Use the method of moment area to show that the vertical deflection of the cantilever at point C is:

$$y_C = \frac{P(a+b)^3}{3EI}. \quad (3)$$

[2b] (3 pts) Use the method of moment area to show that the vertical deflection of the cantilever at point B is:

$$y_B = \frac{Pa^2}{6EI}[3b+2a]. \quad (4)$$

Now suppose that a roller support is inserted below point B as follows:

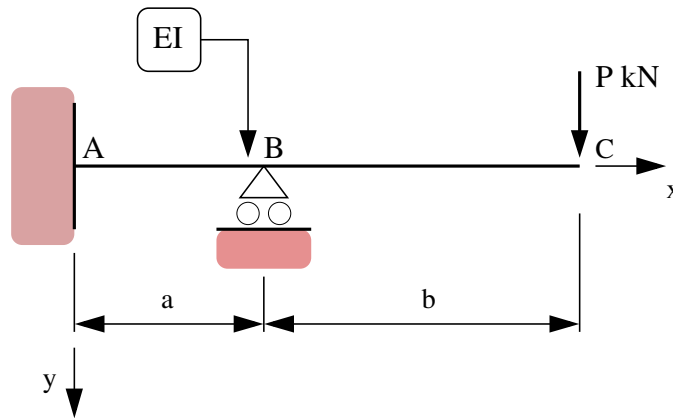

Figure 4: Front elevation view of a cantilever supported by a roller at point B.

[2c] (3 pts) Show that the vertical support reaction at B is:

$$V_b = \frac{P}{2} \left[\frac{3b + 2a}{a} \right]. \quad (5)$$

[2d] (3 pts) Hence, derive a simple expression for the bending moment at A.

Finally, let's replace the roller support below point B with a spring.

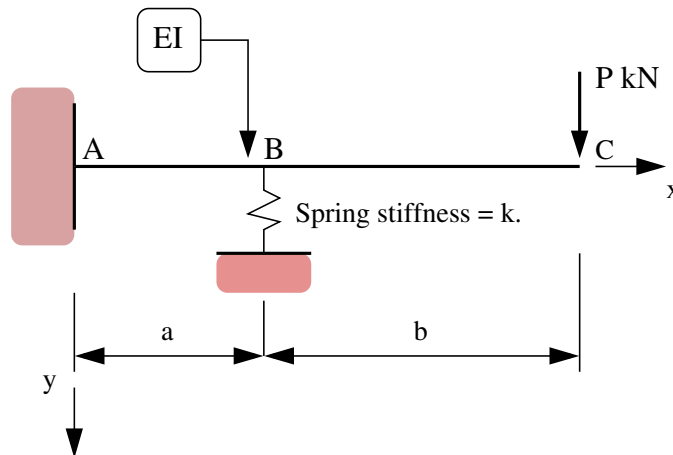

Figure 5: Cantilever supported by a spring at point B.

[2e] (4 pts) Show that the support reaction, V_b , is now given by the equation:

$$V_b \left[\frac{1}{k} + \frac{a^3}{3EI} \right] = \frac{Pa^2}{6EI} [3b + 2a]. \quad (6)$$

[2f] (4 pts) Explain why V_b for spring support (i.e., equation 6) is always lower than for roller support (i.e., equation 5).

Question 3: 10 points

Consider the cantilevered beam structure shown in Figure 6.

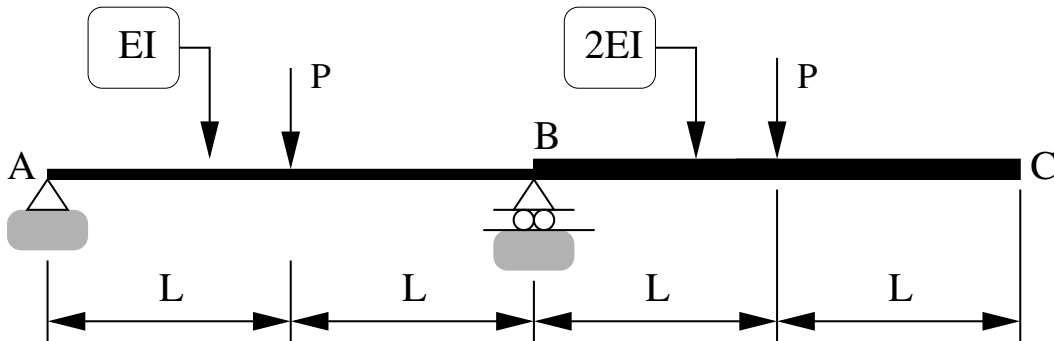

Figure 6: Front elevation view of a cantilevered beam structure.

Notice that segments A-B and B-C have cross-sectional properties EI and $2EI$, respectively.

[3a] Use the method of moment-area to compute the rotation at point A.

[3b] Use the method of moment-area to compute the vertical deflection of the beam at point C.

[3c] Draw the deflected shape of the beam.