

ENCE 353: An Overview of Structural Analysis and Design

Mark Austin

Fall Semester 2017

Outline

- Objectives of Structural Engineering
- A little history
- Structural Engineering Process
- Types of loads
- Types of structures
- Civil Engineering Materials
- Load paths in structures
- How can structures fail?
- Summary

Objectives of Structural Engineering

Structural engineering is ...

... the field of engineering particularly concerned with the design of economical and efficient load-bearing structures.

Within civil engineering, it is largely ...

... the implementation of mechanics to the design of the large structures that are fundamental to basic living, such as buildings, bridges, walls, dams, and tunnels.

Structural design is ...:

... the process of determining location, material, and size of structural elements to resist forces acting in a structure

Objectives of Structural Engineering

Structural engineers need to design structures that ...

... do not collapse or behave in undesirable ways while serving their useful functions.

The efficient use of funds and materials to achieve these structural goals is also a major concern.

Structural engineers work closely with geotechnical engineers, architects, construction managers, and transportation engineers, to name only a few.

How do I become a Structural Engineer?

Apprentice structural engineers may design ...

... simple beams, columns, and floors of a new building, including calculating the loads on each member and the load capacity of various building materials (steel, timber, masonry, and concrete).

An experienced engineer would tend to design more complex structures, such as multistory buildings or bridges.

It is in the design of these more complex systems that a structural engineer must draw upon creativity -- **this will be part design and part art** -- in the application of mechanics principles.

A Little History

Exemplars of Early Work



- Great Pyramid of Giza, Egypt (20 year construction; finished 2556 BC).
- The Parthenon in Ancient Greece (447-438 BC).
- Construction of the Great Wall of China (220 BC).
- The Romans developed civil structures throughout their empire, including especially aqueducts, insulae, harbours, bridges, dams and roads.

A Little History

Year	Milestone
1854	Bessemer invents steel converter.
1849	Monier develops reinforced concrete.
1863	Siemens-Martin open hearth process makes steel available in bulk.



A Little History

Early Skyscrapers

Skyscrapers (1890s) create habitable spaces in tall buildings for office workers.

Enablers	Example: Empire State Building
<ul style="list-style-type: none">● New materials → design of tall structures having large open interior spaces.● Elevators (1857) → vertical transportation building occupants.● Mechanical systems → delivery of water, heating and cooling.● Collections of skyscrapers → high-density CBDs/commuter society.	

A Little History

Exemplars of Work from the 1800s and 1900s

From the 1800s	From the 1900s
Erie Canal (1825)	New York City Subway (1904)
Transcontinental Railroad (1869)	The Panama Canal (1914)
Brooklyn Bridge (1883)	Holland Tunnel (1927)
Washington Monument (1884)	Empire State Building (1931).
	Hoover Dam (1936).
	Golden Gate Bridge (1937)
	Interstate Highway System (1956)

Source: Celebrating the Greatest Profession, Magazine of the American Society of Civil Engineers, Vol. 72, No. 11, 2002.

Looking Ahead

Example. Engineering Modern Skyscrapers

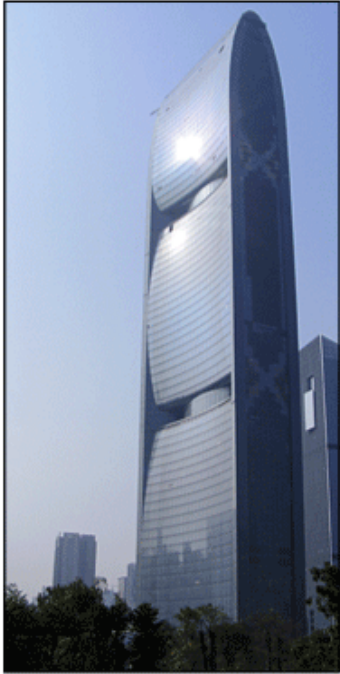
Enablers	Example: Pearl River Tower
<ul style="list-style-type: none">● High performance structure designed to produce as much energy as it consumes.● Guides wind to a pair of openings at its mechanical floors.● Winds drive turbines that generate energy for the heating, ventilation and air conditioning systems.● Openings provide structural relief, by allowing wind to pass through the building.	

Structural Design Process

- Determine types magnitudes of loads and forces acting on the structure
- Determine structural context
 - geometric and geological information
 - cost / schedule / height/ etc. limitations
- Generate alternative structural systems (e.g., moment resistant frame, materials selection),
- Analyze one or more alternatives
- Select and perform detailed design
- Implement (usually done by contractor)

Note: New structural systems may also require an experimental testing phase to verify behavior and system performance.

Formal Approach to Structural Design

Formal Approaches to Behavior Modeling and Decision Making

Appropriate formalisms depend on the design domain of interest.

- Physical aspects of behavior are often characterized by differential equations.
- Logical aspects of system design can be captured by binary and multi-valued logic variables and boolean equations.

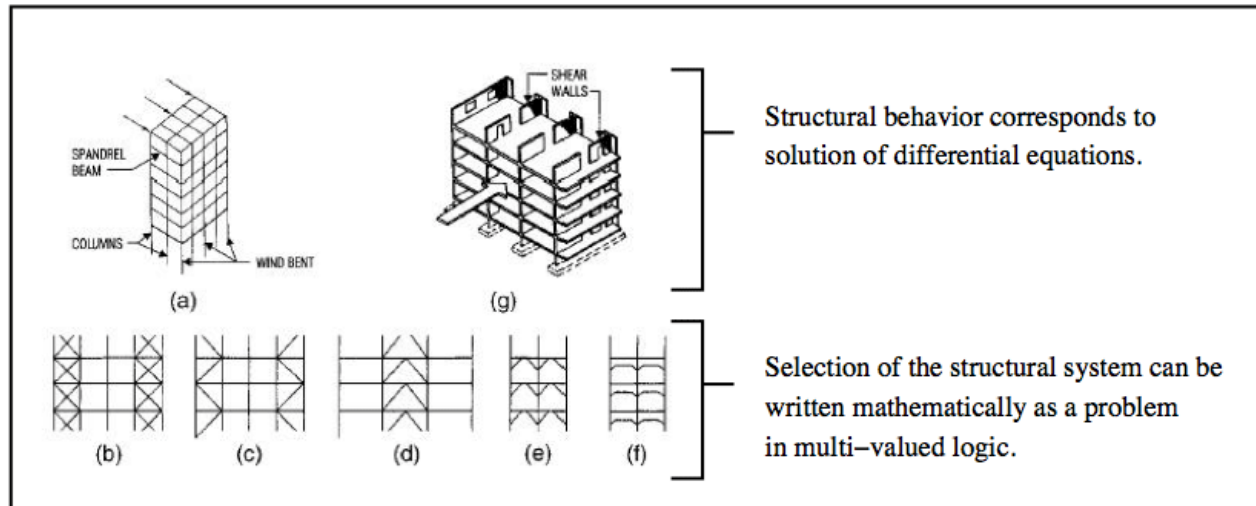

Formal Approach to Structural Design

Structural Behavior

Time-dependent behavior corresponds to solutions of:

$$[M] \frac{d^2 x}{dt^2} + [C] \frac{dx}{dt} + [K] x = P(t). \quad (1)$$

Here,

- M, C, and K are $(n \times n)$ matrices,
- x is a $(n \times 1)$ vector of displacements,
- P(t) is a vector of external loads applied to the structural degrees of freedom.

Design Parameters

- Selection of the best structural system (e.g., braced system) from a list of options.
- Size of the beams, columns, and bracing (if required).

Types of loads

- Dead loads
- Live loads
- Dynamic loads (e.g., trains, equipment)
- Wind loads
- Earthquake loads
- Thermal loads
- Settlement loads

Dead Loads

- weight of the structure itself
 - floors, beams, roofs, decks, beams/stringers, superstructure
- loads that are “always there”



Live Loads

- People, furniture, equipment
- Loads that may move or change mass or weight
- Minimum design loadings are usually specified in the building code



Load Example: Live Load in Ballroom

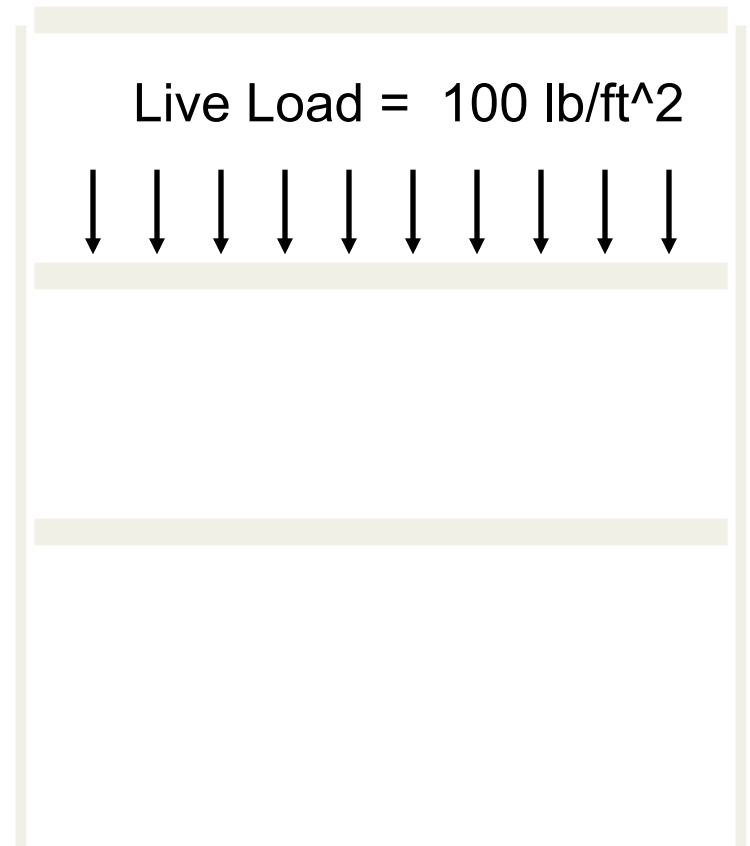
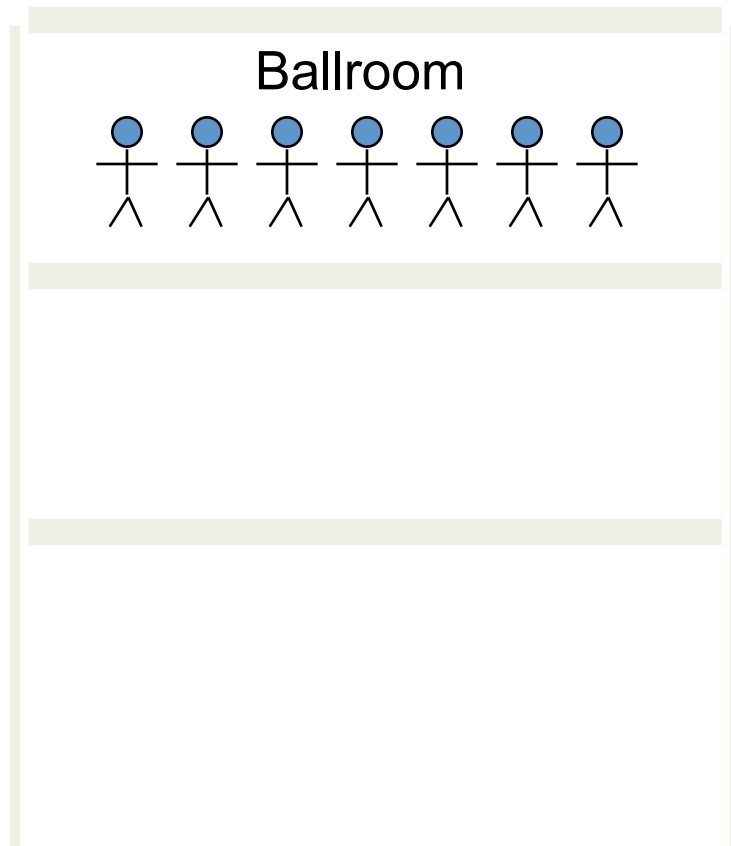

Dynamic Loads

- Moving loads (e.g., traffic)
- Impact loads
- Gusts of wind
- Loads due to cycling machinery



Load Example: Dynamic Load

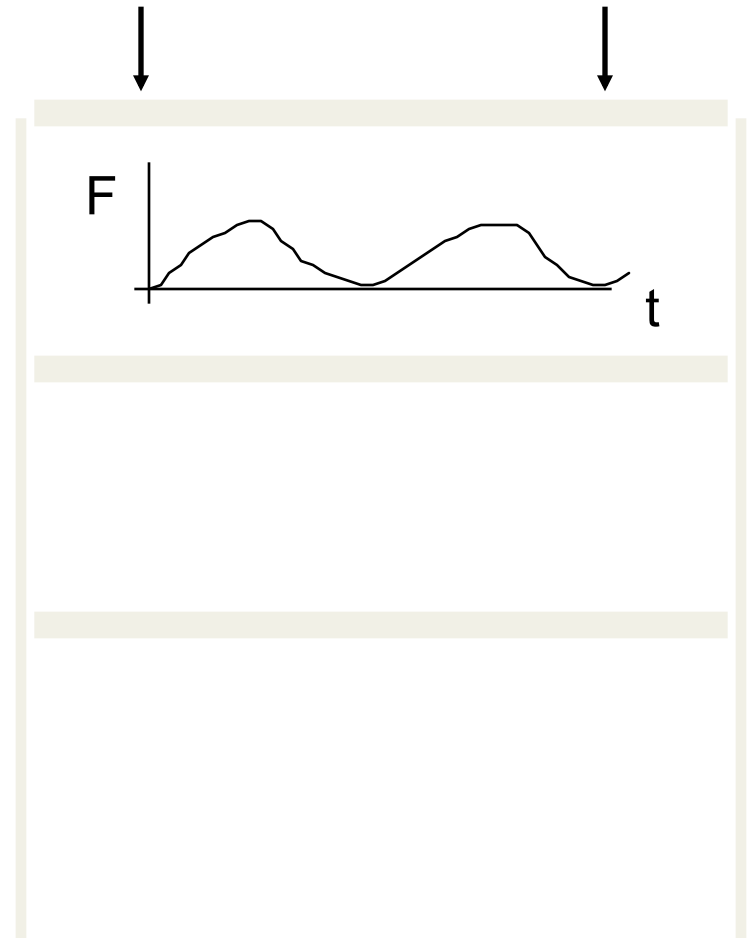
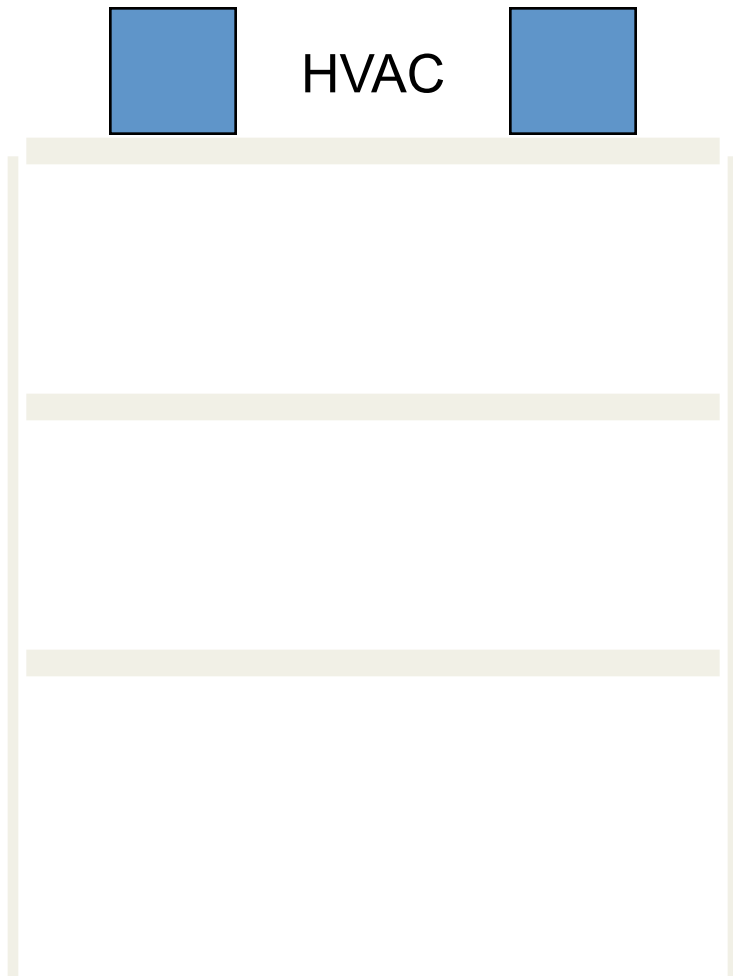

Load Example: Water in a dam

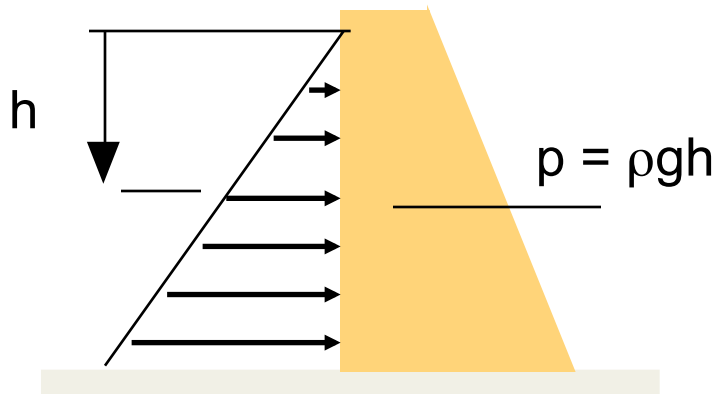
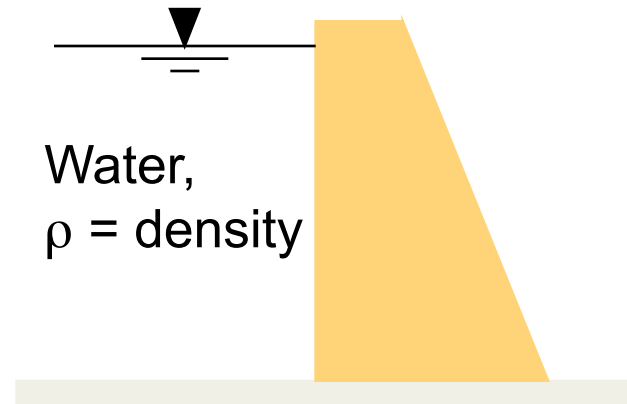

Earthquake Loads

- Structure loaded when base is shaken
- Response of structure is dependent on the frequency of motion
- When frequencies match with natural frequency of structure - resonance

Load Example: Earthquake Load

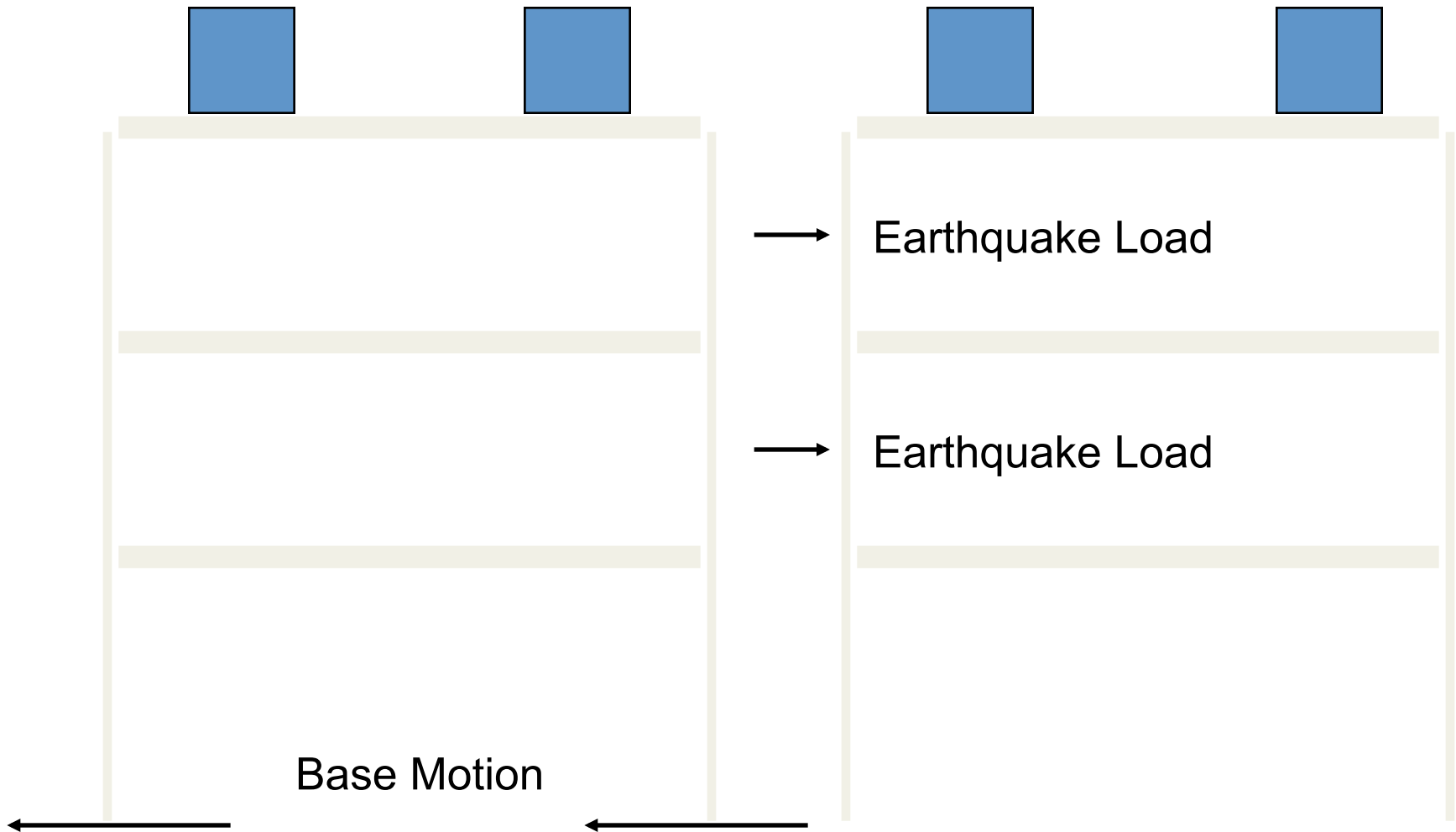

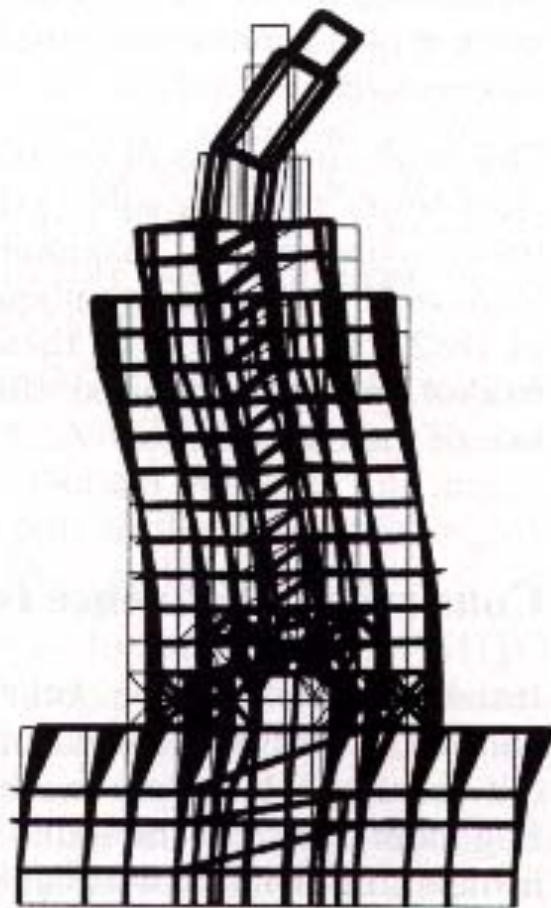

Fixed Base

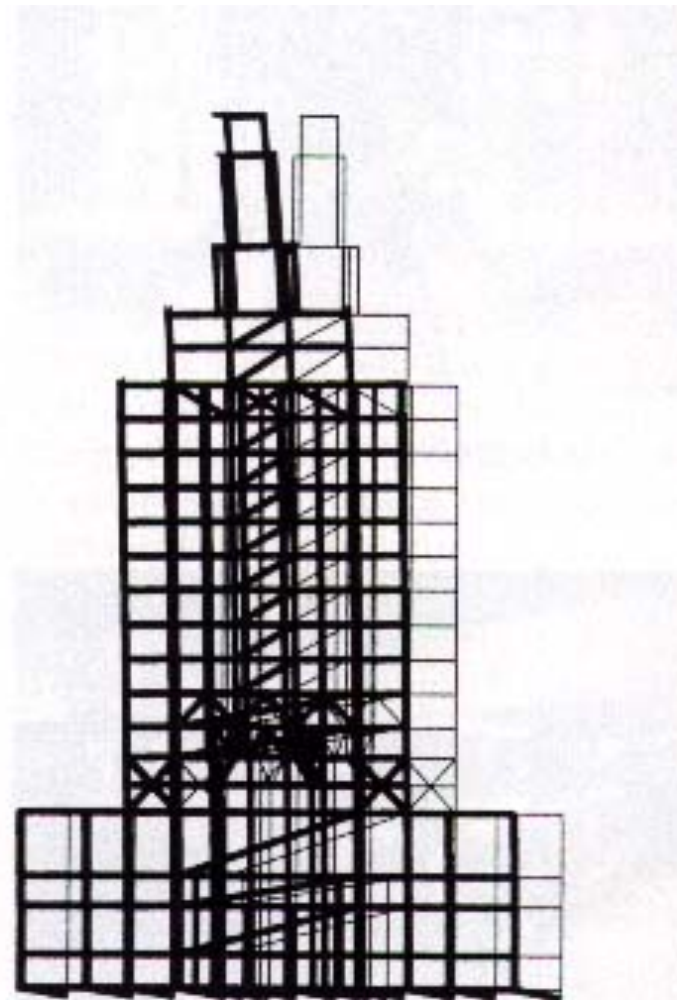

Isolated

4: Seismic response of the building

Settlement



...structure, I accepted the appointment in spite of my advanced age, then 80. I was determined to see that the Tower survived.

The Committee was constituted as follows:

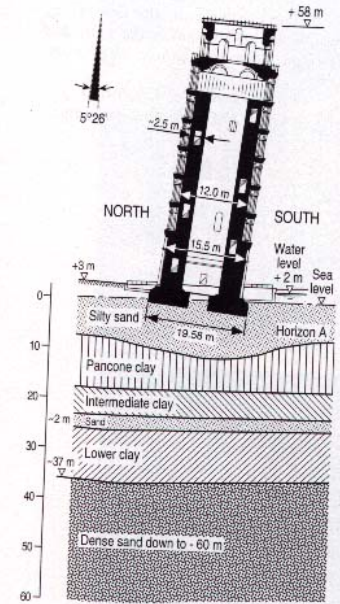

Fig. 2: Soil profile

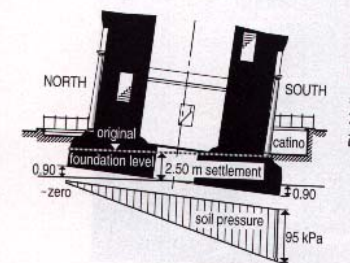
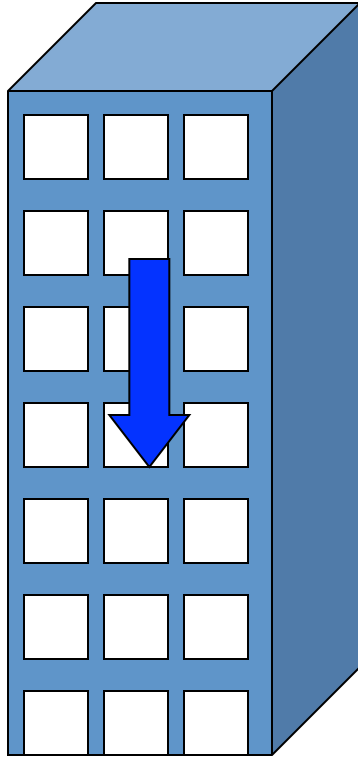

Fig. 3: Settlement and soil pressure

Forces Acting in Structures

- Forces induced by gravity
 - Dead Loads (permanent): self-weight of structure and attachments
 - Live Loads (transient): moving loads (e.g. occupants, vehicles)
- Forces induced by wind
- Forces induced by earthquakes
- Forces induced by rain/snow
- Fluid pressure

Forces Acting in Structures



Vertical: Gravity

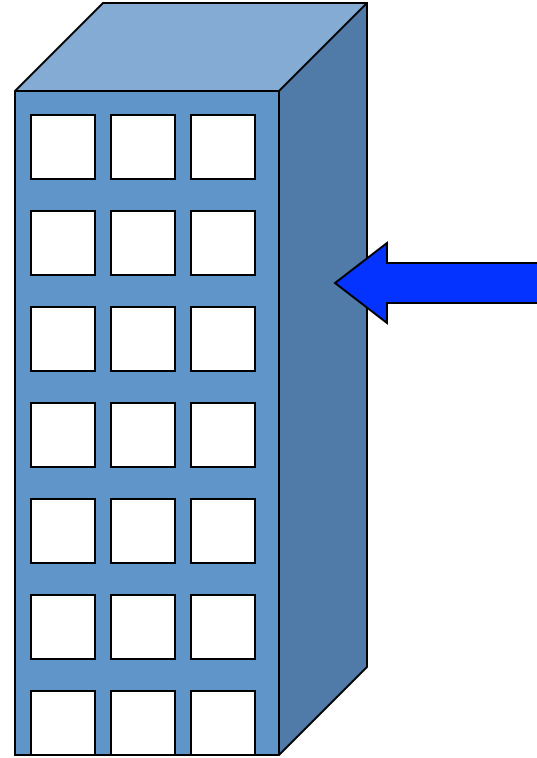

Lateral: Wind, Earthquake

Global Stability

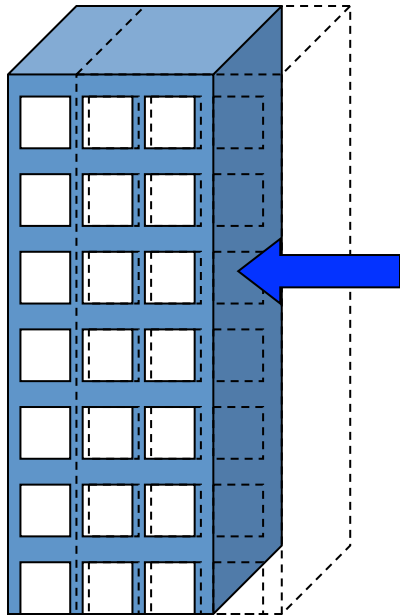

Sliding

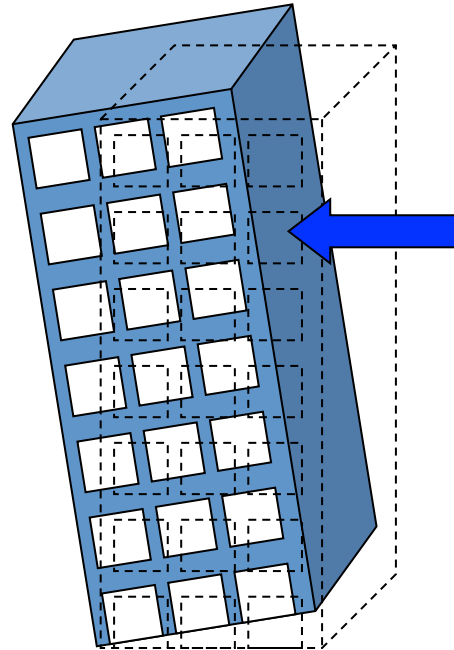

Overturning



Forces in Structural Elements

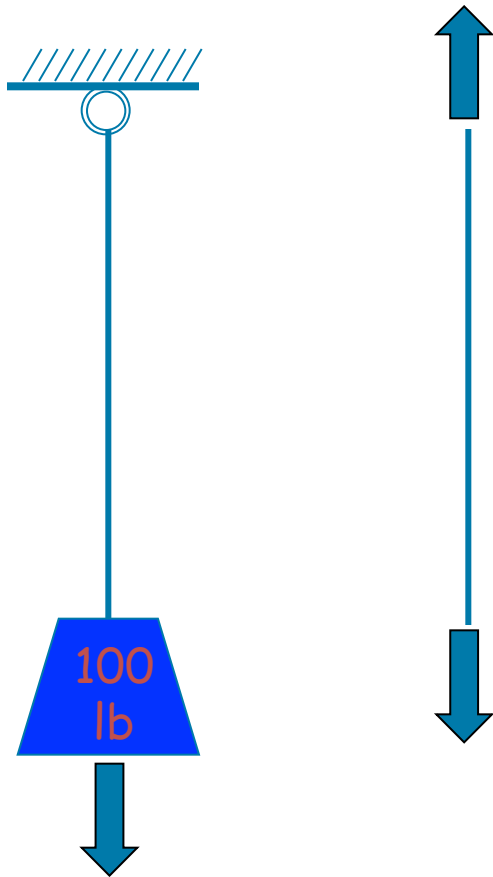

Tension

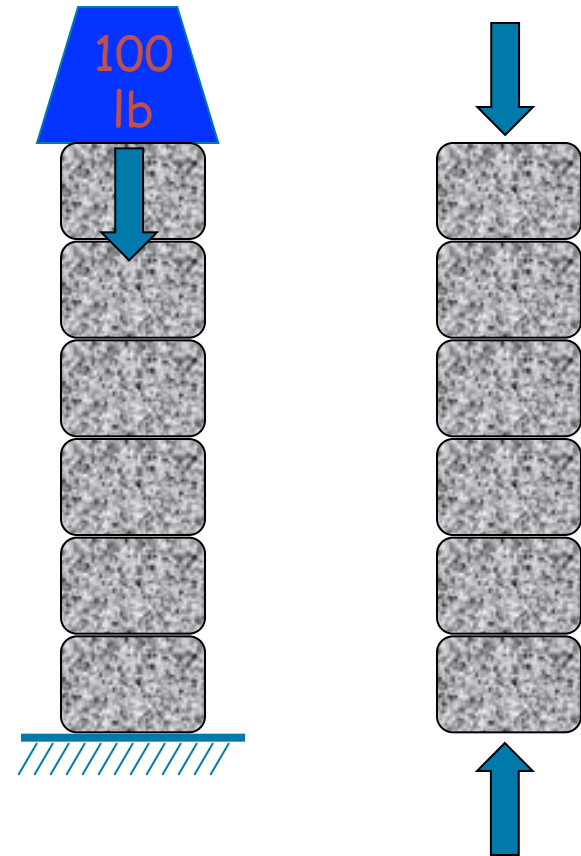

Compression

Forces in Structural Elements (cont.)

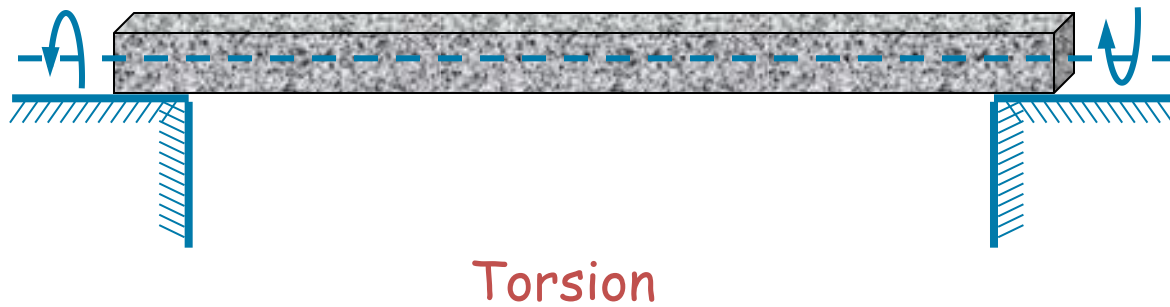
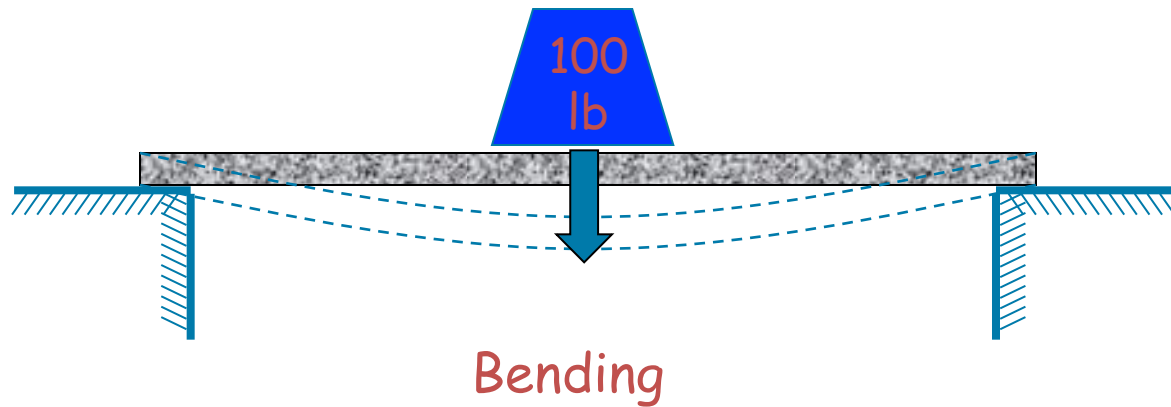

Some Types of Structures

- Arch
- Planar Truss
- Beam/Girder
- Flat plate
- Braced and Rigid Frames
- Folded Plate and Shell Structures
- Cable Suspended Structure

Arch

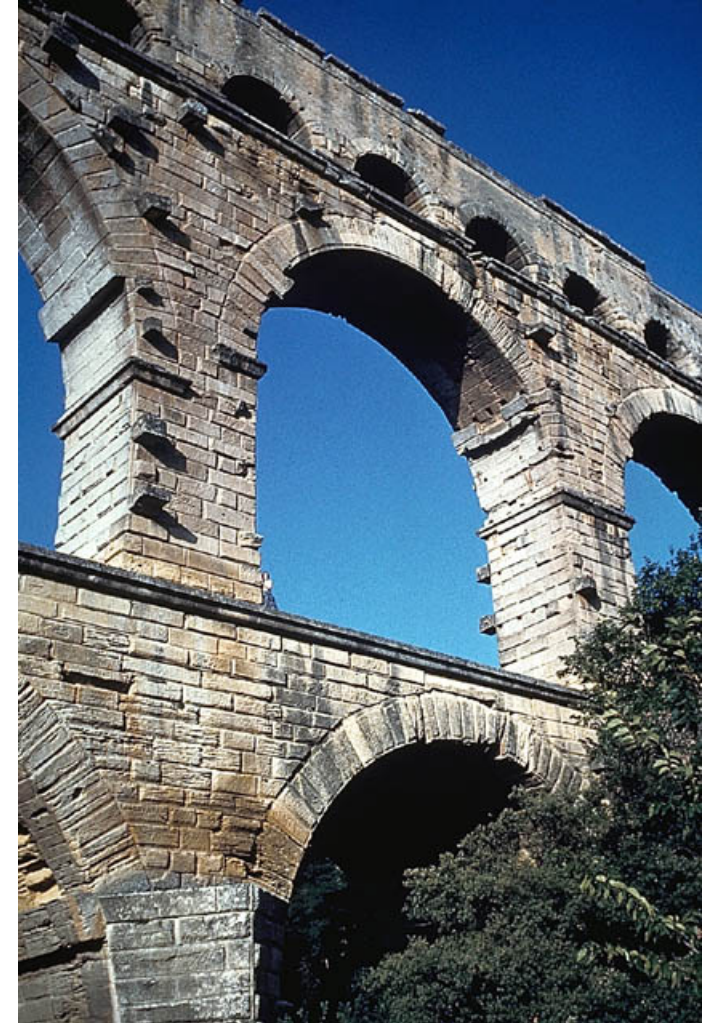
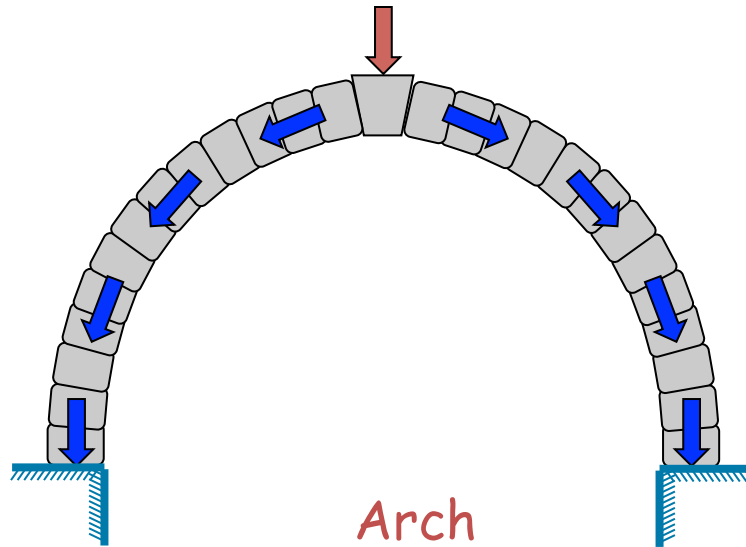

Design objective: Structure needs to work and be aesthetically pleasing!!

Analysis objective: What shape should the arch be so that forces can be transferred to the foundation through compression mechanisms alone?





Science World,
Vancouver, Canada.



Planar Truss

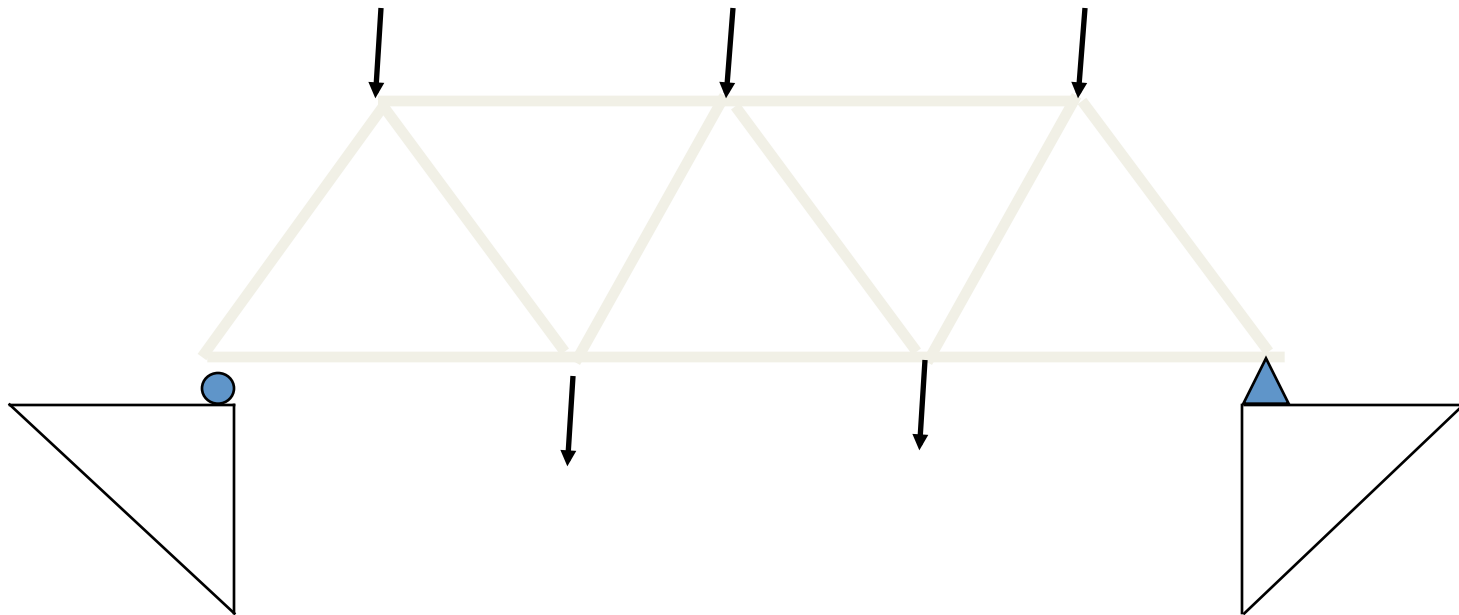

Planar Truss

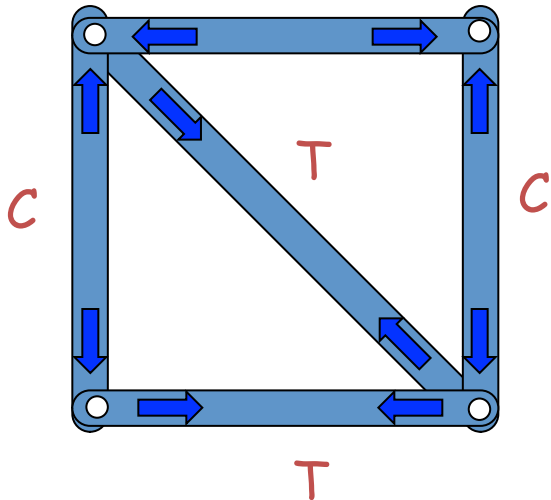
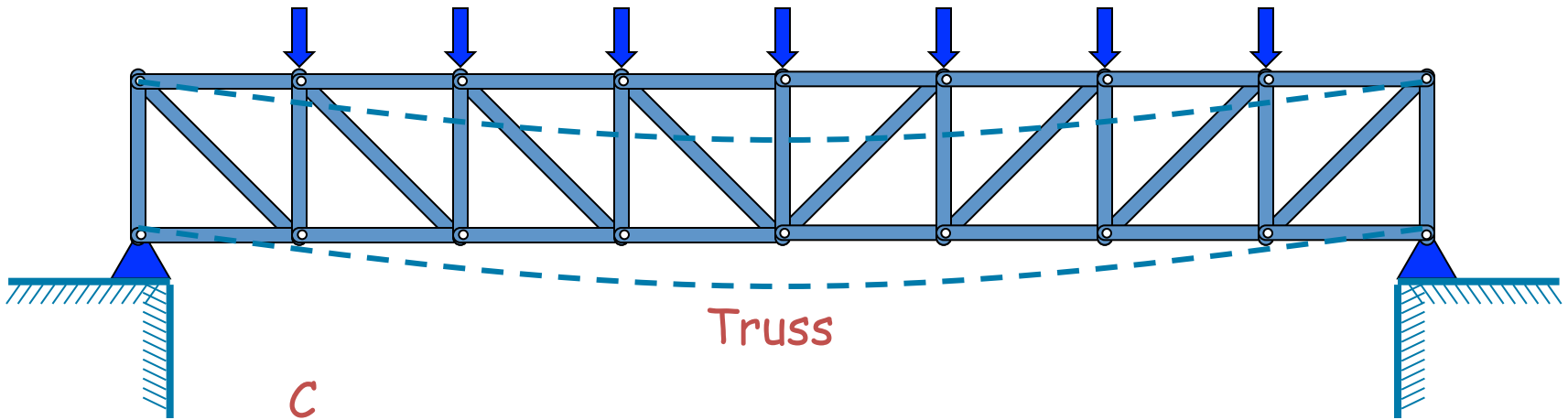

Forces in Truss Members





Truss

- Combination of square and triangle
 - Both vertical and lateral support

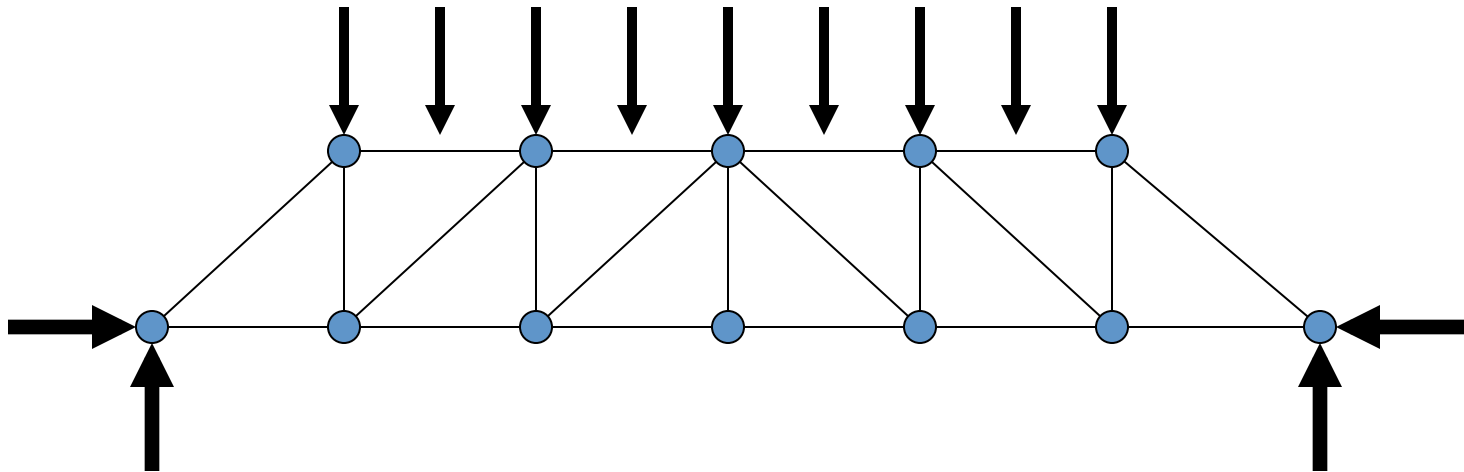

Beam/Girder

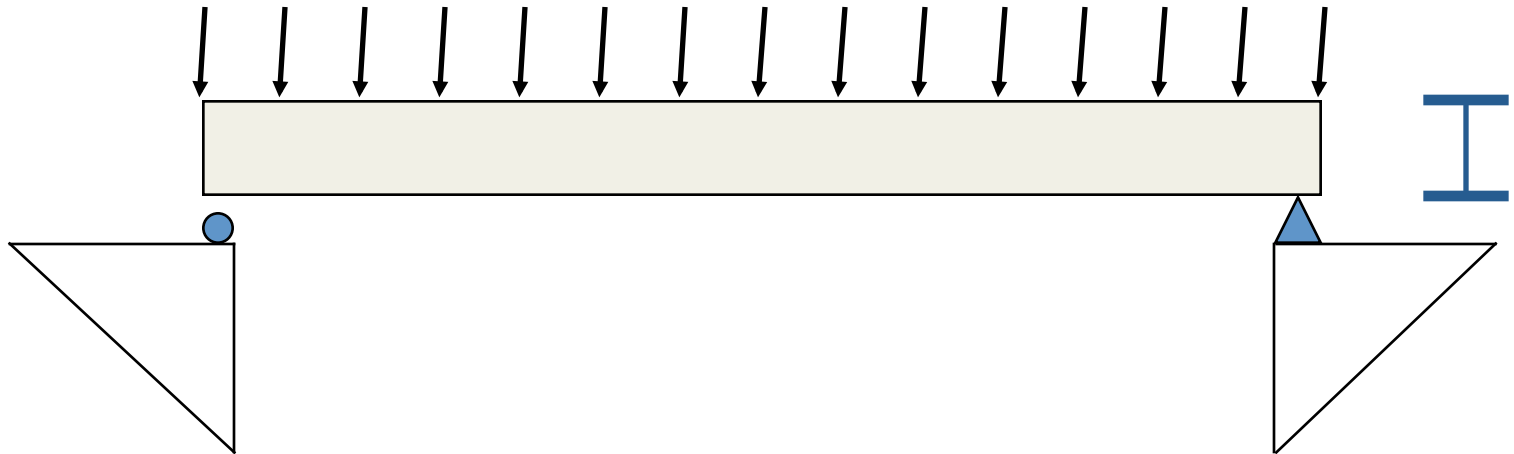





Frames

Braced

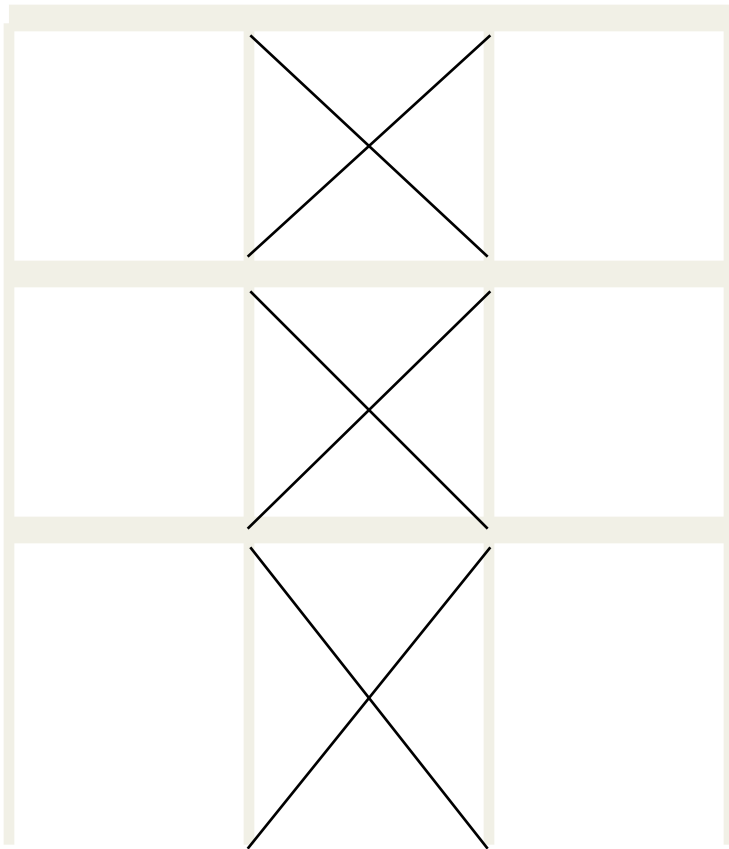

Rigid

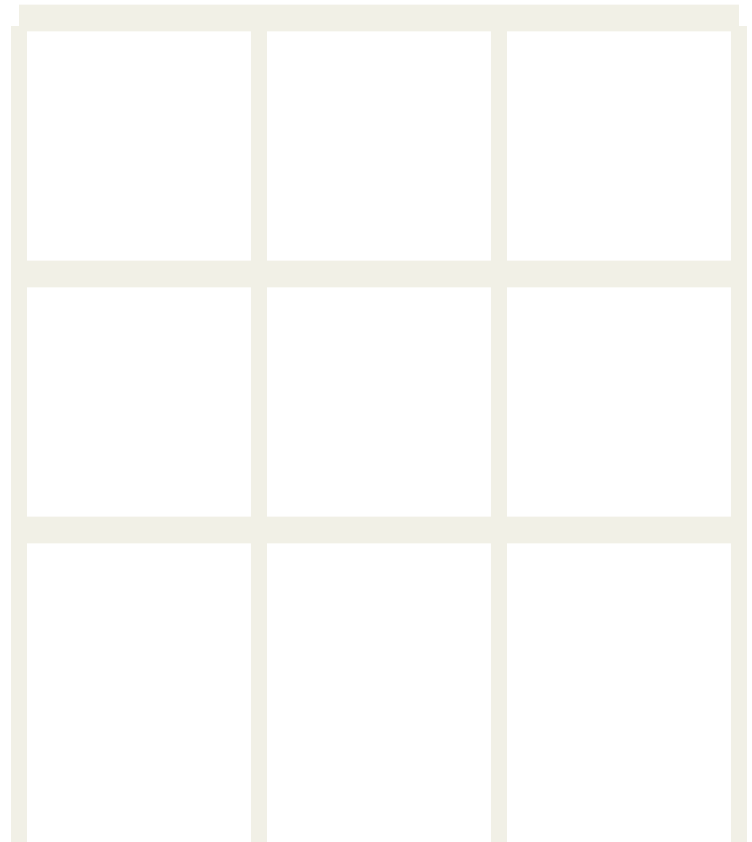

Frames Continued

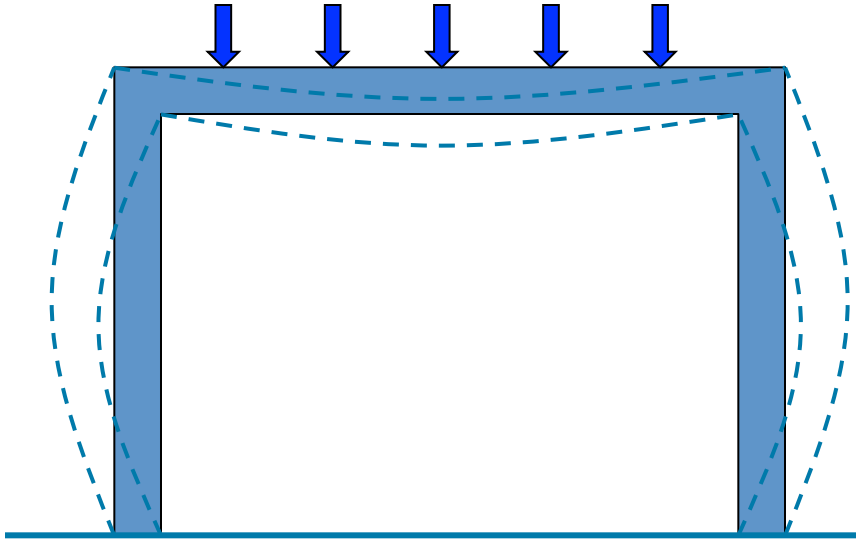

Frame



Analysis objective: We want to compute the distribution of forces – axial, bending moment, shear forces – throughout the structure.

What are the displacements?

Will the frame structure be stable?



Flat Plate



Folded Plate



Shells



Circular Shell Structure



Lattice Shell Structure

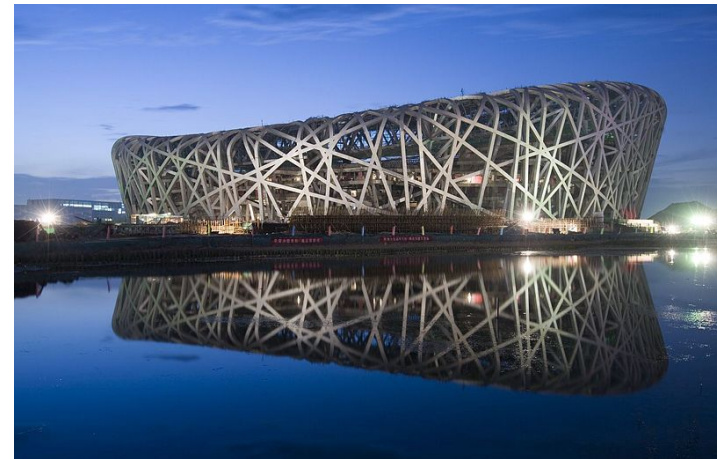

Cable Suspended Structure

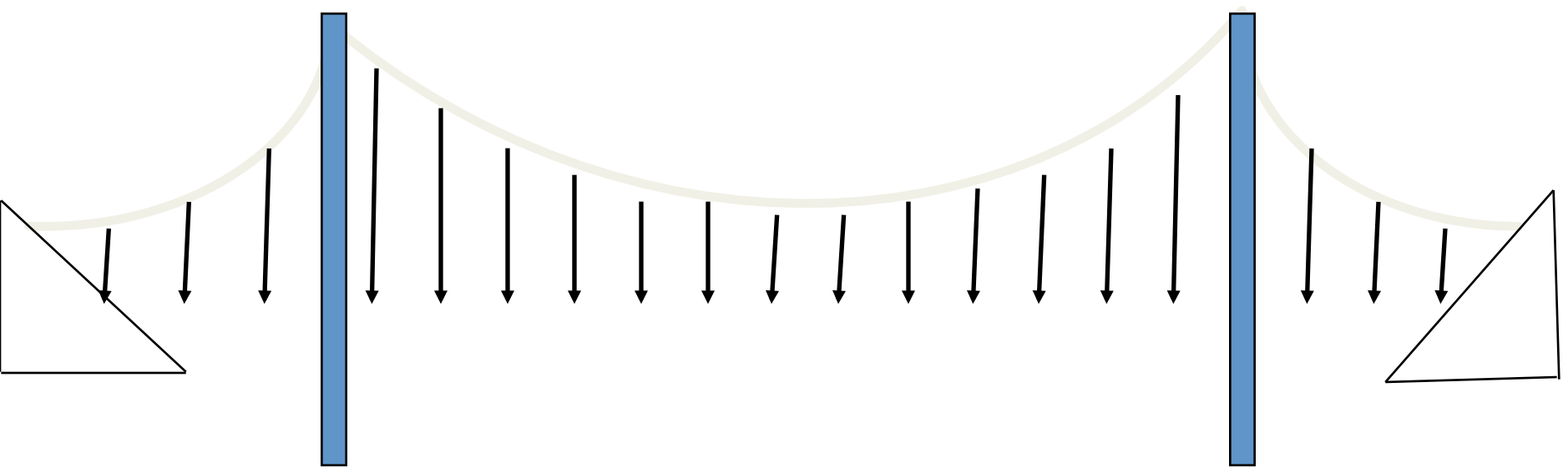

Analysis objective: What are the forces in the cable structure? How will the cable profile shape change with different distributions of live load? What are the bending moments in the bridge deck?



Cable Stayed Bridge

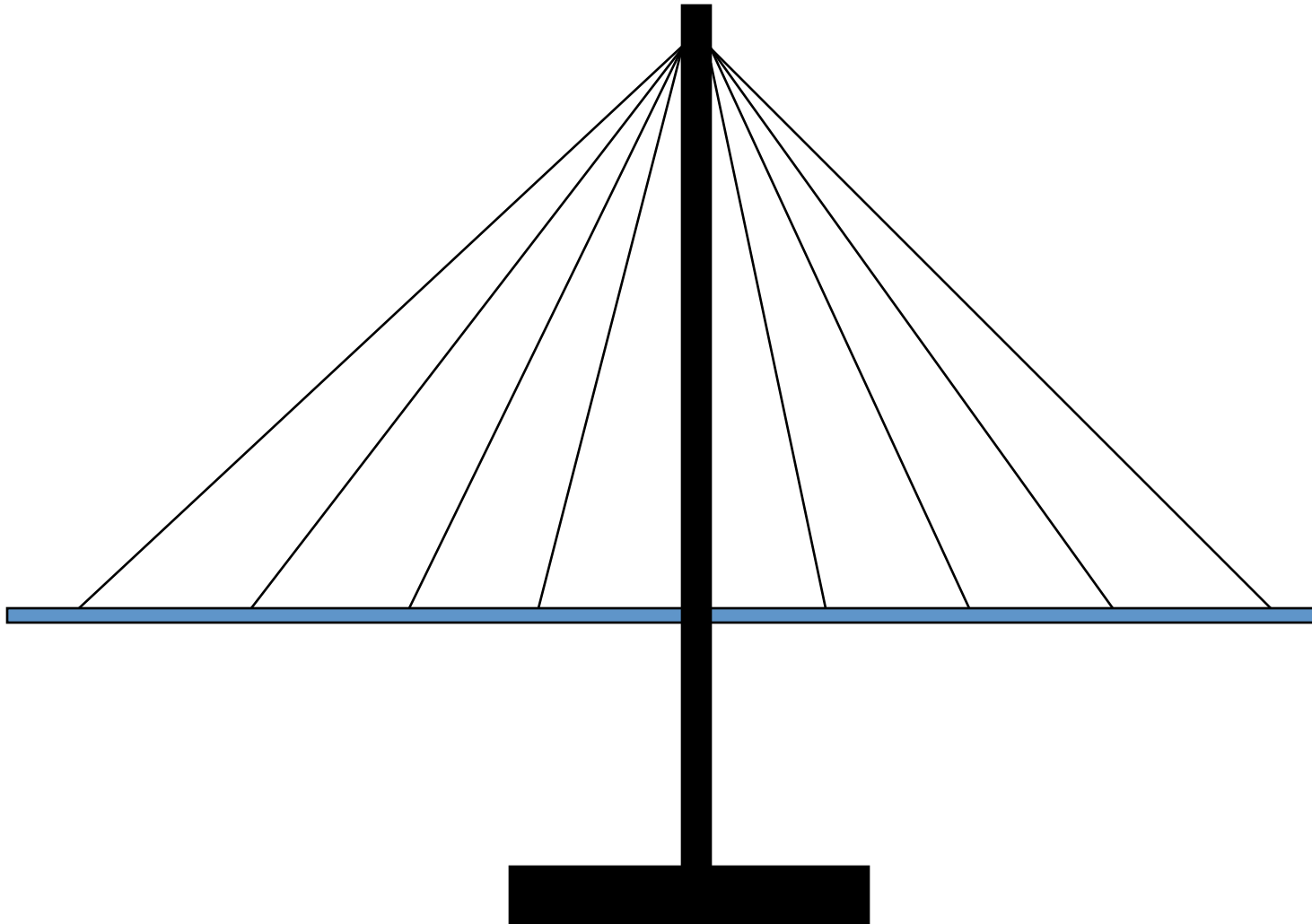

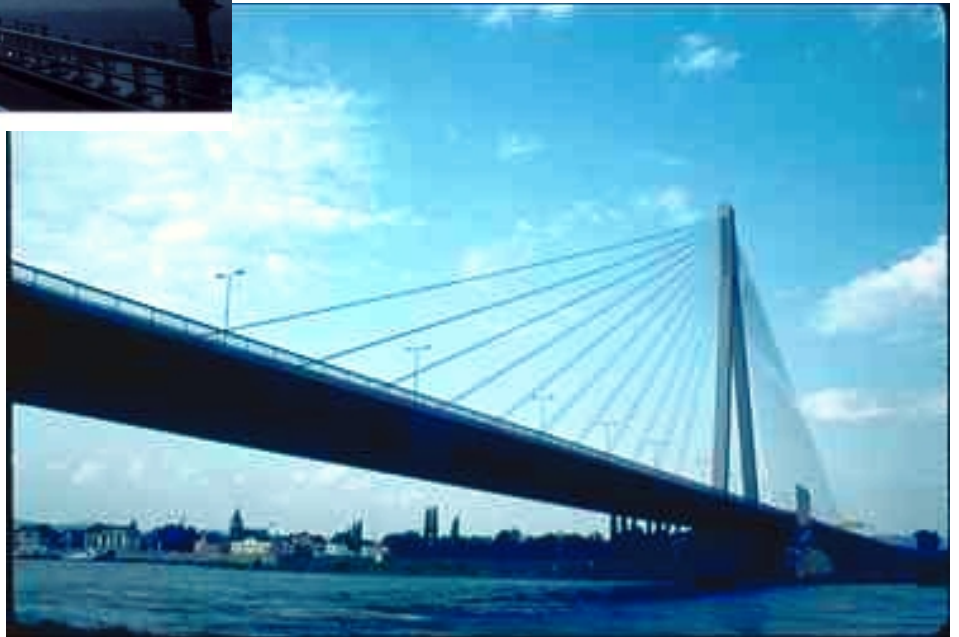

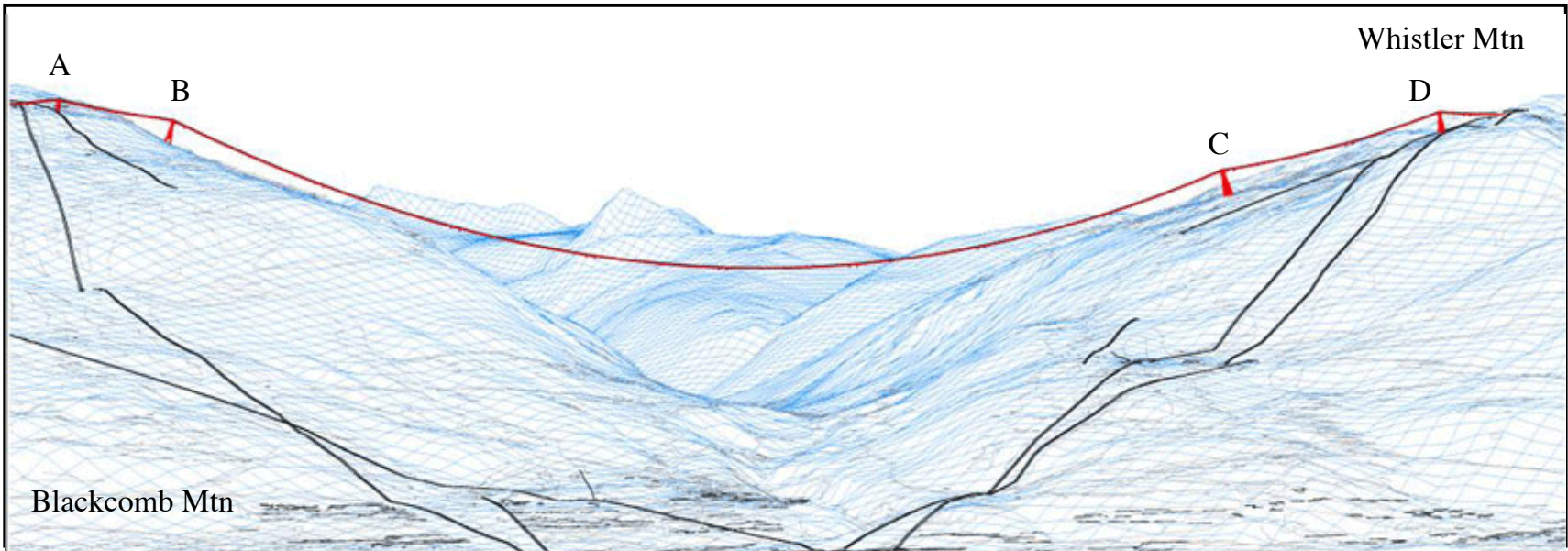

Blackcomb Mtn

Whistler Mtn



WORLD RECORDS

World's Longest unsupported (free) span for a lift of this kind in the world
 World's Highest lift of its kind
 World's Longest continuous lift system

TECHNICAL DETAILS

SPEED 7.5 metres per second
CROSSING TIME 11 minutes
FREQUENCY 1 cabin departs every 49 seconds
TOTAL DISTANCE 4.4 km (2.73 miles)
LENGTH OF UNSUPPORTED SPAN 3.024 km (1.88 miles)
HIGHEST POINT 436 metres (1,427 feet)
NUMBER OF CABINS 28
CAPACITY OF CABINS 24 seated, 4 standing
TOTAL LIFT CAPACITY 4,100 passengers per hour
NUMBER OF TOWERS 4 (2 on each mountain)
HEIGHT OF TOWERS 35 - 65 metres
TRACK ROPES (2) 56 mm diameter, 4600 metres long
HAUL ROPES (1) 46 mm diameter, 8850 metres long

Load Paths in Structures

- Load Path is the term used to describe the path by which loads are transmitted to the foundations
- Different structures have different load paths
- Some structures have only one path
- Some have several (redundancy good)

Load Path in Framed Structure

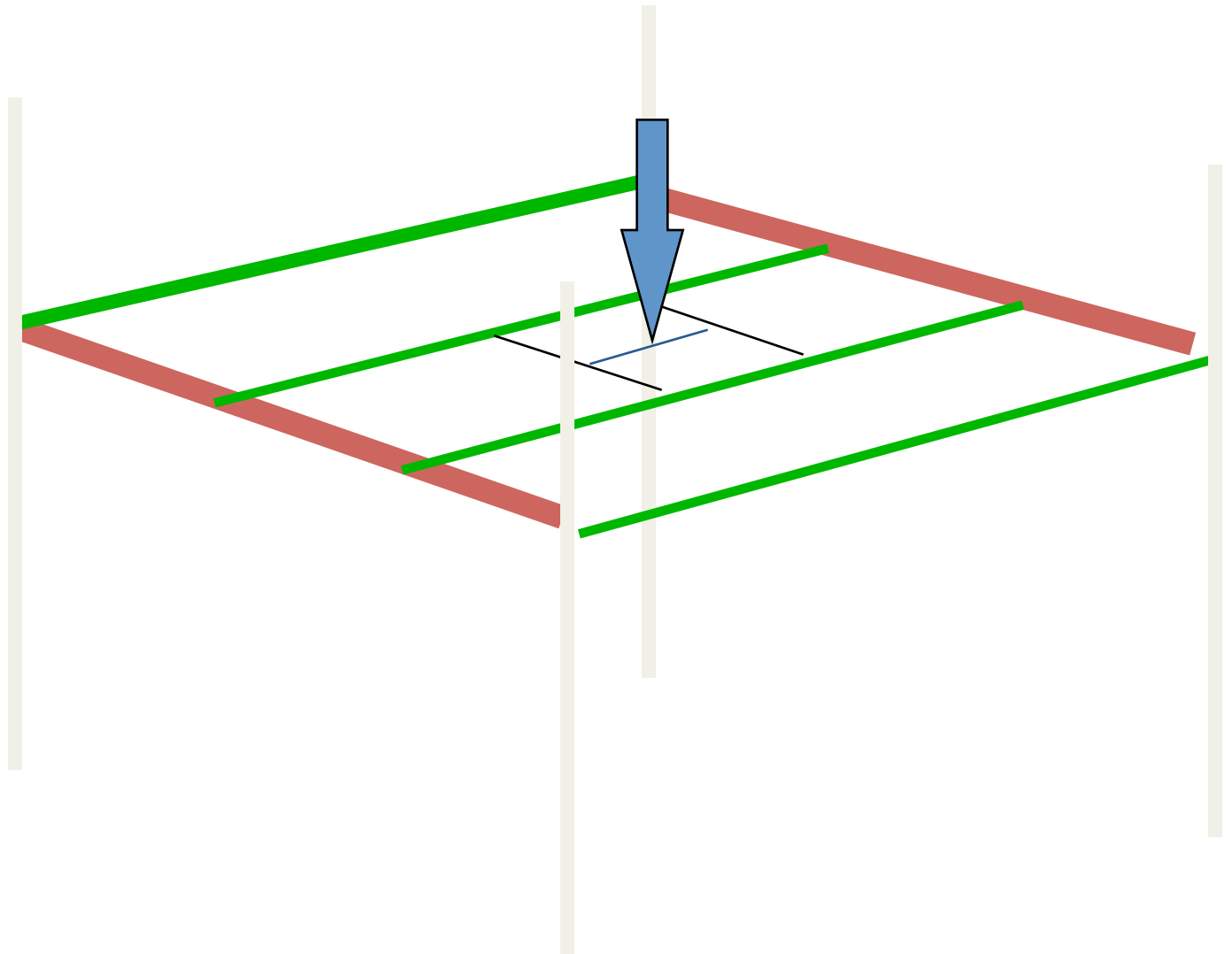

Structural Components

- Beams
- Girders
- Columns
- Floors
- Foundations

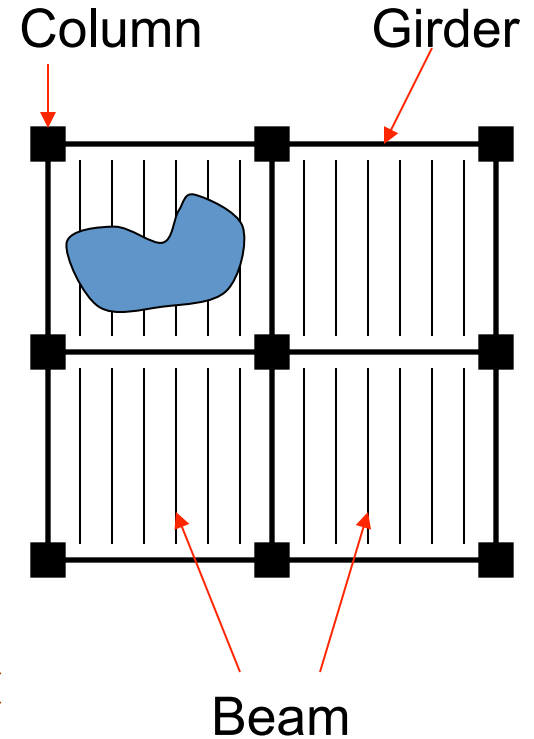
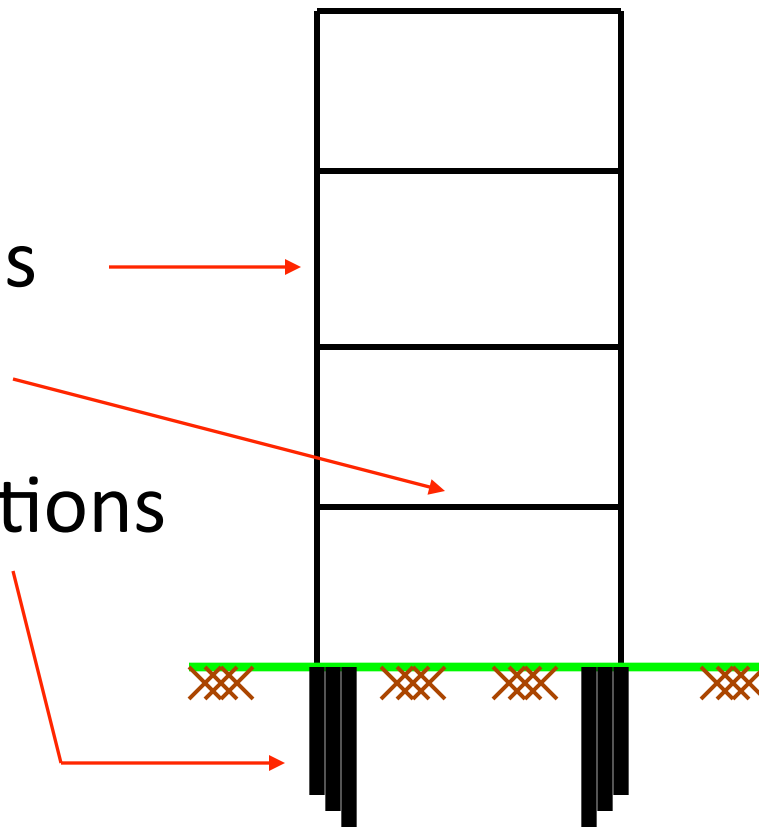

Load Path

- Floor
↓
- Beams
↓
- Girders
↓
- Columns
↓
- Foundation
↓
- Soil/Bedrock

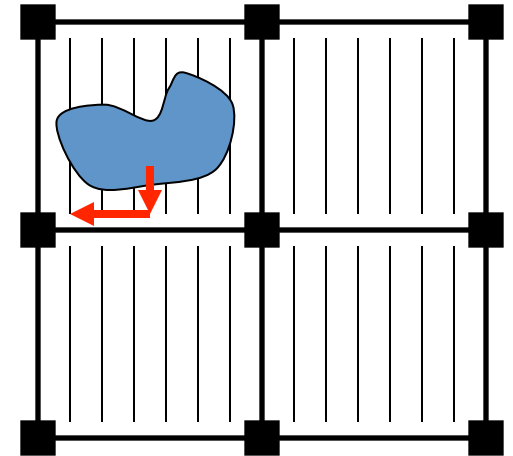
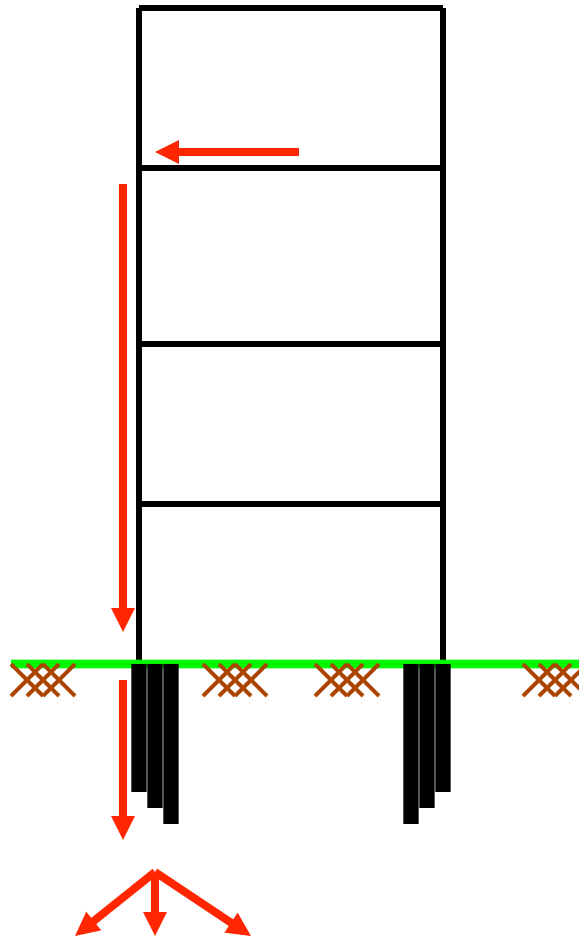

Flooring

- Composed of a subfloor and floor covering
 - Usually leave space for ductwork, wiring, etc.
 - Floor covering ranges from application to application

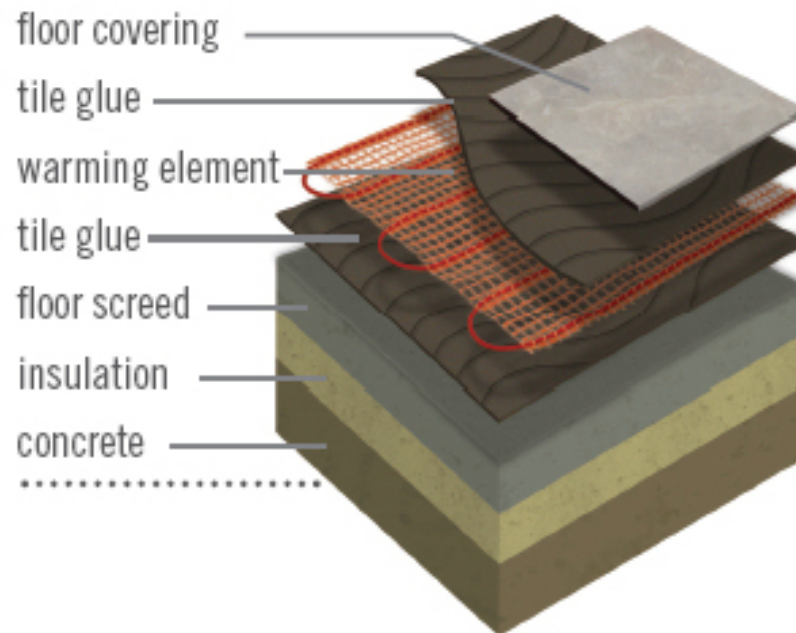

Beams

- Attached between the girders
 - Take load from the flooring system
 - Transfer it to the girders
 - Generally solid squares, I-beams



Girders



- Attached column-to-column
 - Take the load from the beams
 - Transfer it to the columns
 - Generally shaped as an I-Beam



Foundations

- Support the building
 - Typically attached to columns
- Types
 - Shallow
 - Spread footing – concrete strip/pad below the frost line
 - Slab-on-grade – concrete pad on the surface
 - Deep
 - Drilled Shafts
 - Piles

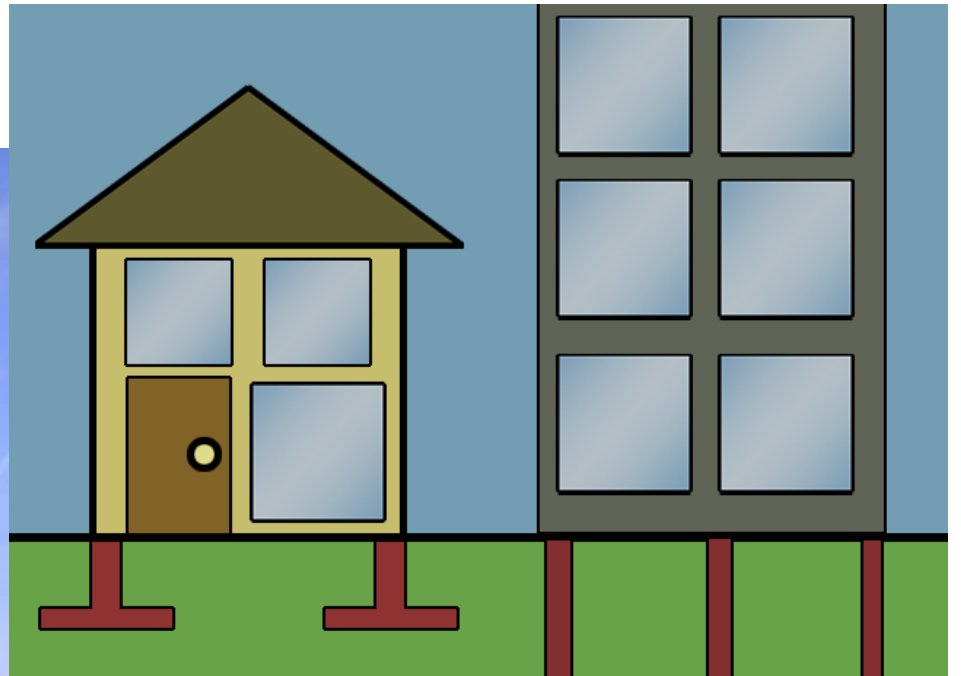

Overview of Structural Behavior

Depends on:

- Material properties (e.g., steel, concrete).
- Structural stiffness (e.g. axial stiffness, bending stiffness)
- Structural strength (e.g., ultimate member strength).

Design challenges:

- If the structural stiffness is too low, then the displacements will be too large,
- In dynamics applications a high structural stiffness may attract high inertia forces.
- If the structural strength is too low, then the structural system may fail prematurely.

Axial Stiffness

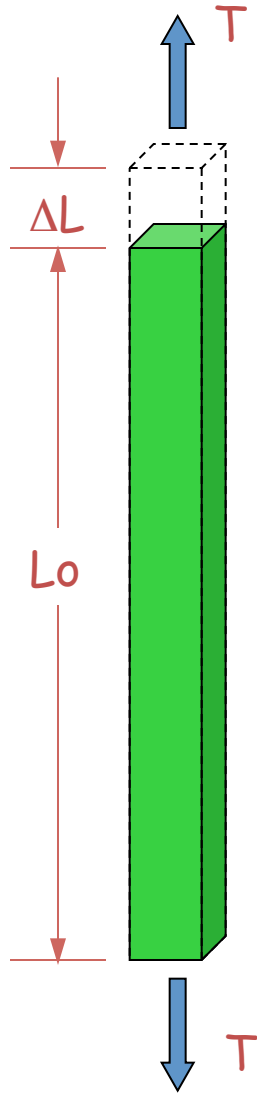

$$\text{Stiffness} = T / \Delta L$$

Example:

$$T = 100 \text{ lb}$$

$$\Delta L = 0.12 \text{ in.}$$

$$\text{Stiffness} = 100 \text{ lb} / 0.12 \text{ in.} = 833 \text{ lb/in.}$$

Bending Stiffness

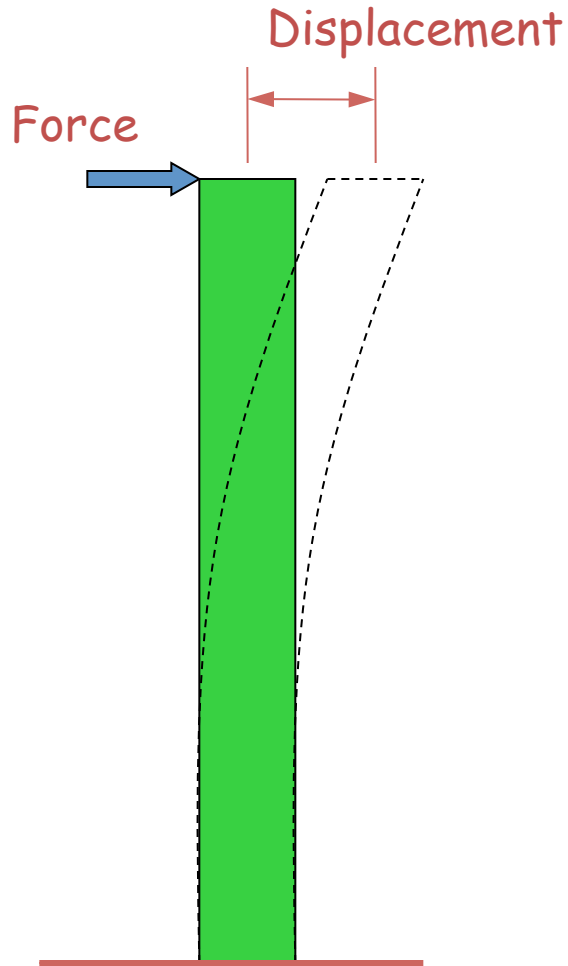

Stiffness = Force / Displacement

Example:

Force = 1,000 lb

Displacement = 0.5 in.

Stiffness = 1,000 lb / 0.5 in. = 2,000 lb/in.

Definition of Stress

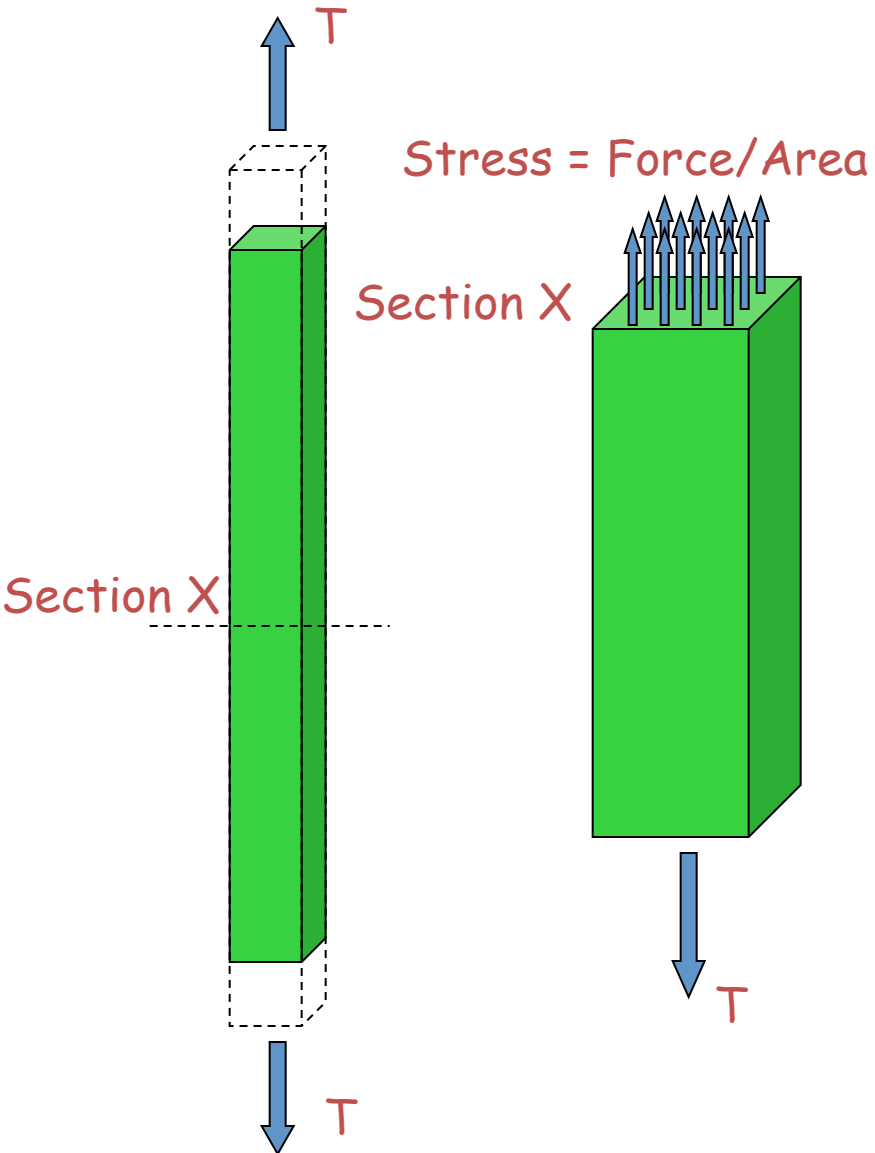

Example (English Units):

$T = 1,000 \text{ lb (1 kip)}$
 $A = 10 \text{ in}^2$

$\text{Stress} = 1,000/10 = 100 \text{ lb/in}^2$

Example (SI Units):

$1 \text{ lb} = 4.448 \text{ N (Newton)}$
 $1 \text{ in} = 25.4 \text{ mm}$

$T = 1,000 \text{ lb} \times 4.448 \text{ N/lb} = 4448 \text{ N}$
 $A = 10 \text{ in}^2 \times \frac{(25.4 \text{ mm})^2}{(1 \text{ in})^2} = 6450 \text{ mm}^2$

$\text{Stress} = 4448/6450 = 0.69 \text{ N/mm}^2 \text{ (MPa)}$

Definition of Strain

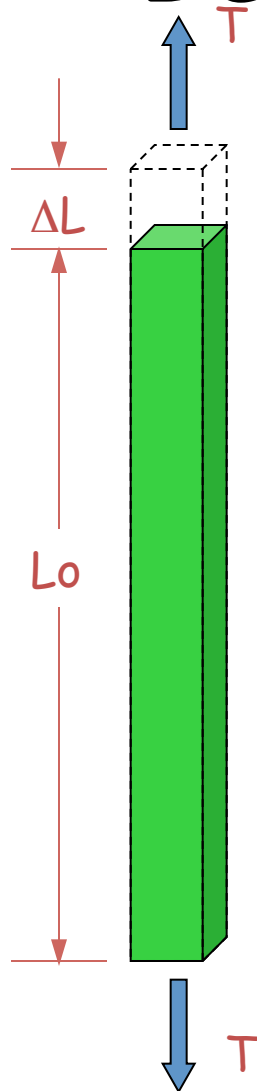

$$\text{Strain} = \Delta L / L_0$$

Example:

$$L_0 = 10 \text{ in.}$$

$$\Delta L = 0.12 \text{ in.}$$

$$\text{Strain} = 0.12 / 10 = 0.012 \text{ in./in.}$$

Strain is dimensionless!!
(same in English or SI units)

Stress–Strain Behavior of Elastic Mats.

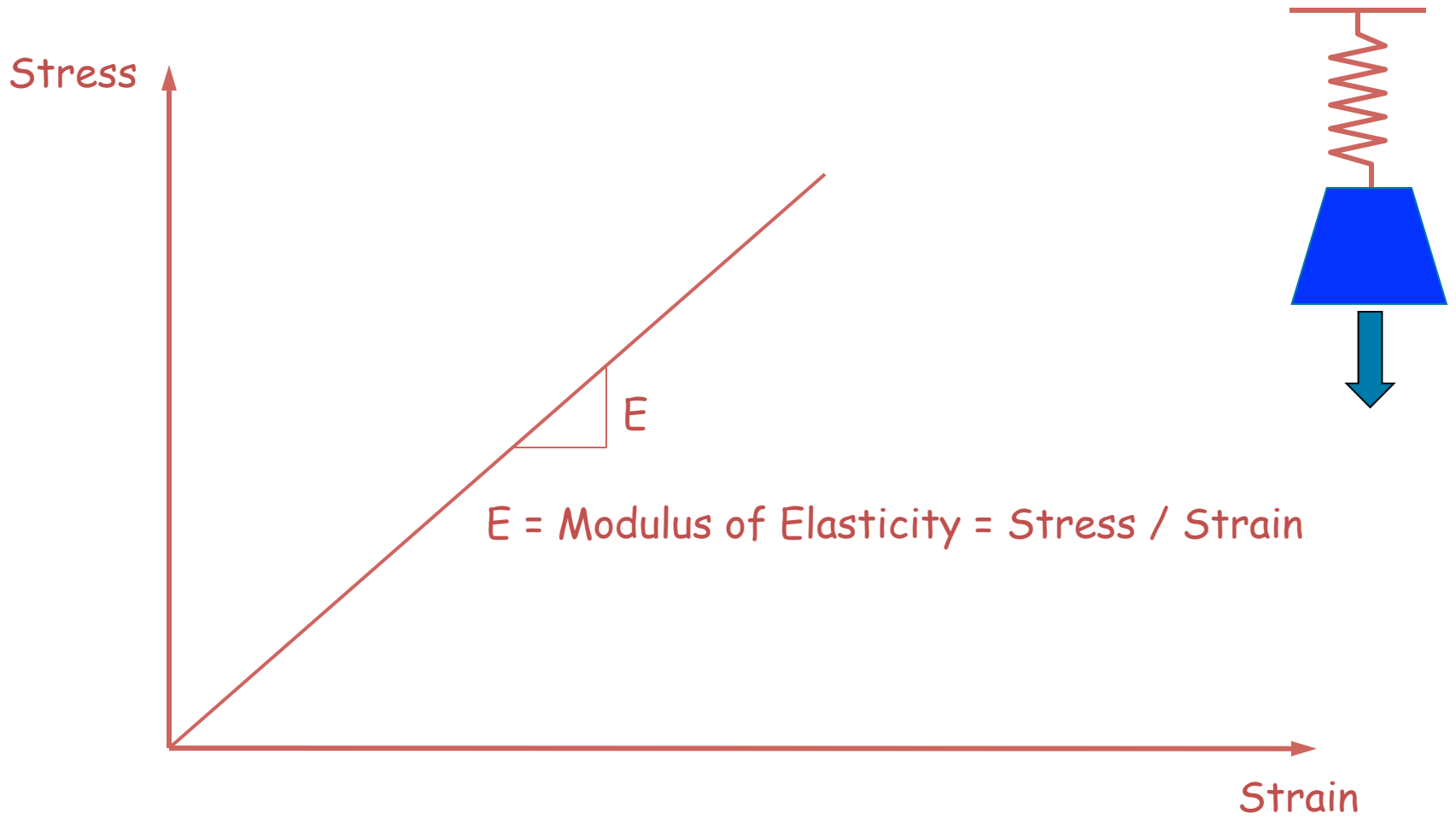

Types of Stress-Strain Behavior

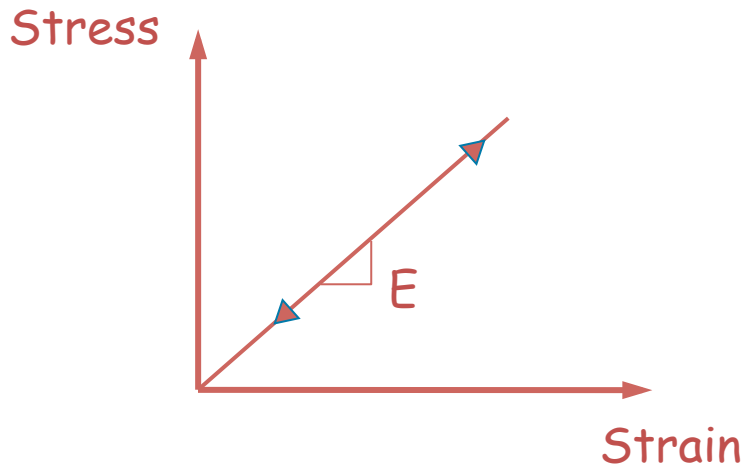

(a) Linear Elastic

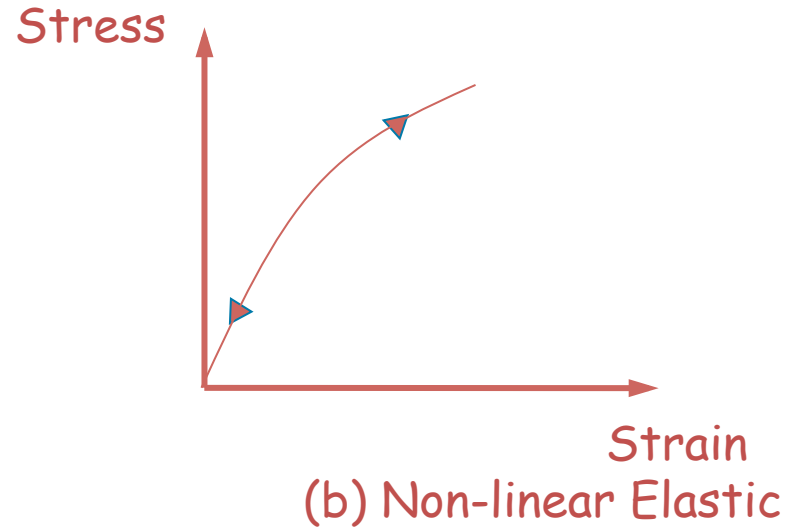

(b) Non-linear Elastic

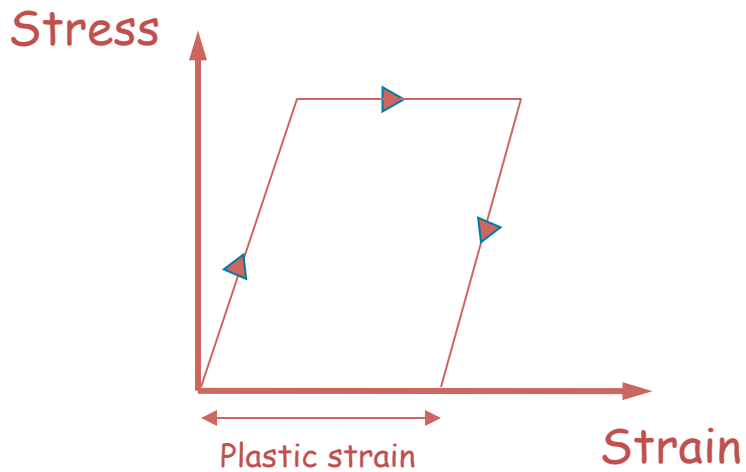

(c) Elastic-plastic

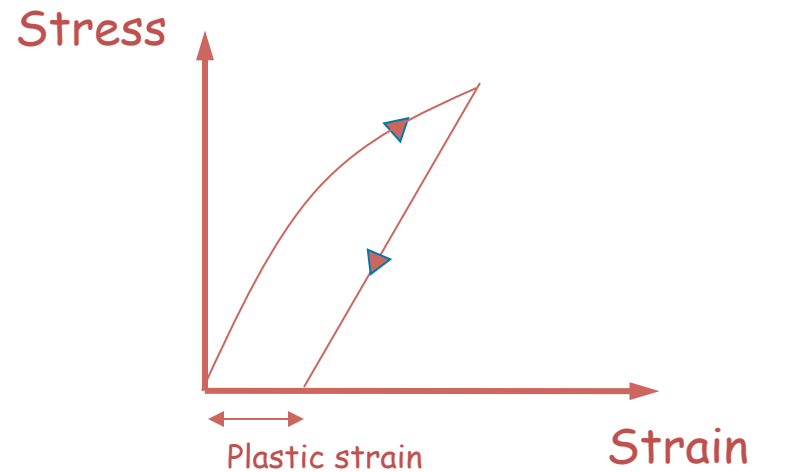

(d) Non-linear Plastic

Types of Structural Elements – Beams

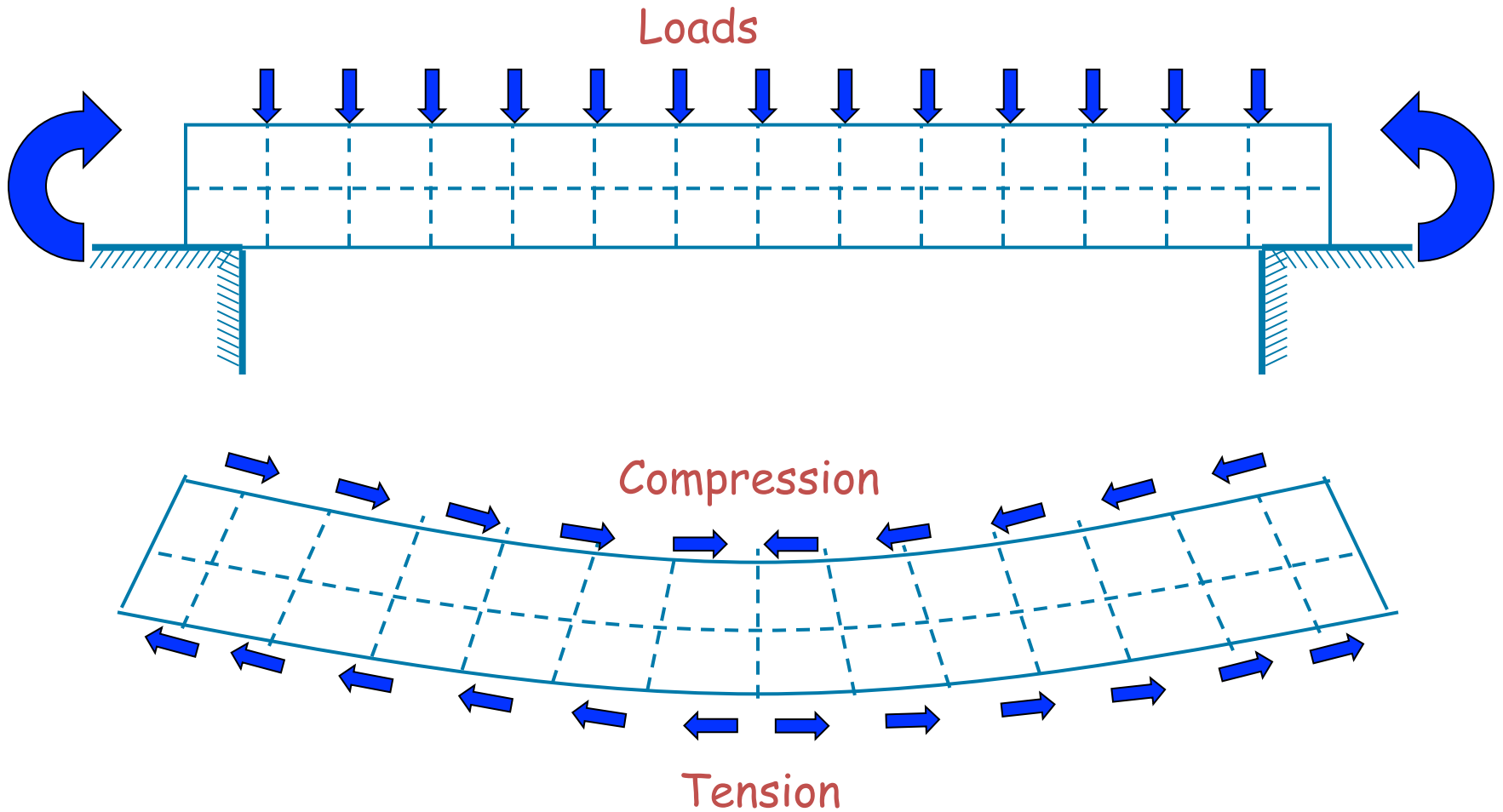

Engineering Properties of Structural Elements

- Strength

- Ability to withstand a given stress without failure

- Depends on type of material and type of force (tension or compression)

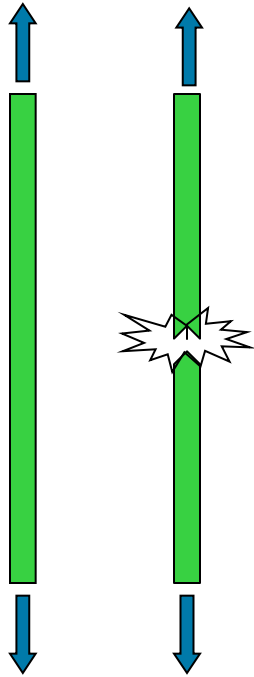

Tensile Failure

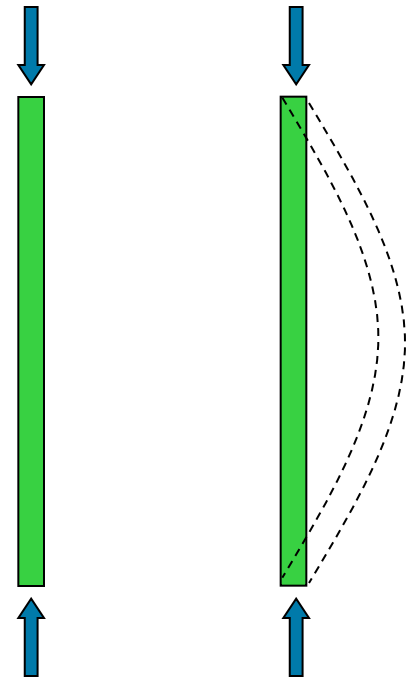

Compressive Failure

Engineering Properties of Materials

- Steel
 - Maximum stress: 40,000 – 120,000 lb/in²
 - Maximum strain: 0.2 – 0.4
 - Modulus of elasticity: 29,000,000 lb/in²
- Concrete
 - Maximum stress: 4,000 – 12,000 lb/in²
 - Maximum strain: 0.004
 - Modulus of elasticity: 3,600,000 – 6,200,000 lb/in²
- Wood
 - Values depend on wood grade. Below are some samples
 - Tension stress: 1300 lb/in²
 - Compression stress: 1500 lb/in²
 - Modulus of elasticity: 1,600,000 lb/in²

Types of Structural Elements – Bars and Cables

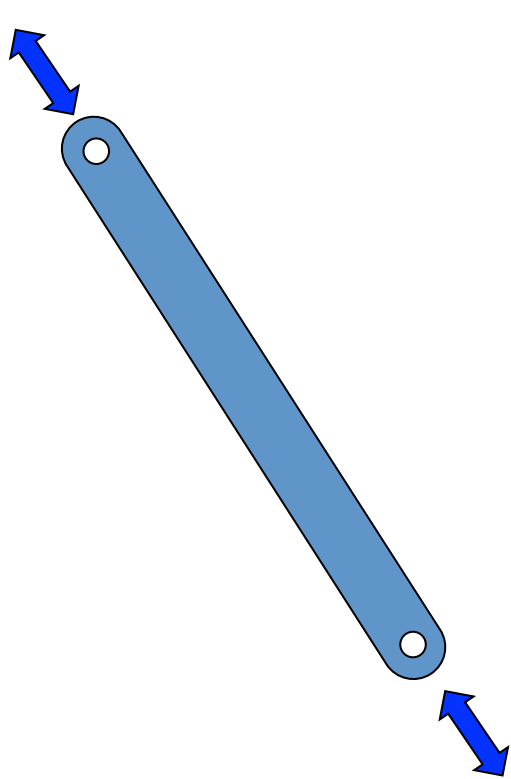

Bars can carry either tension or compression

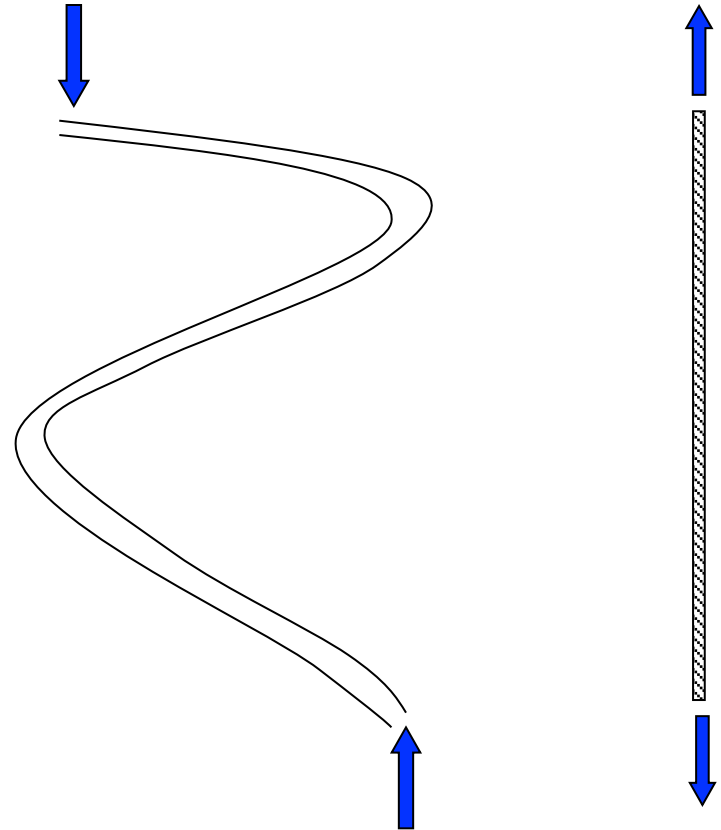

Cables can only carry tension

Stiffness of Different Structural Shapes

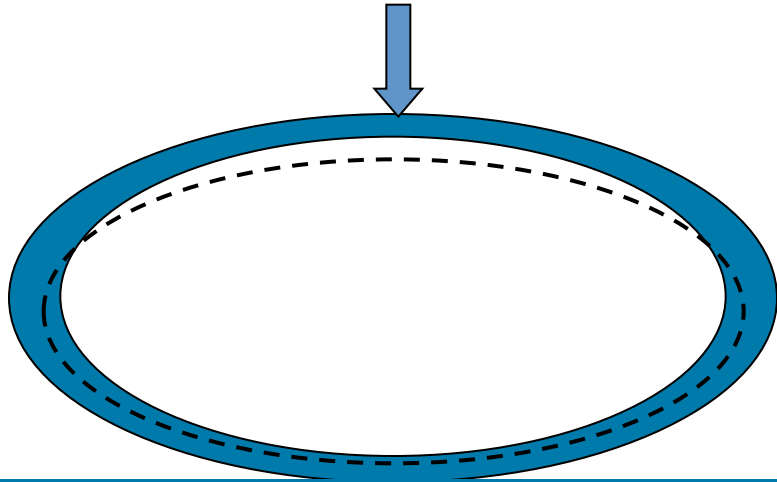

Stiff

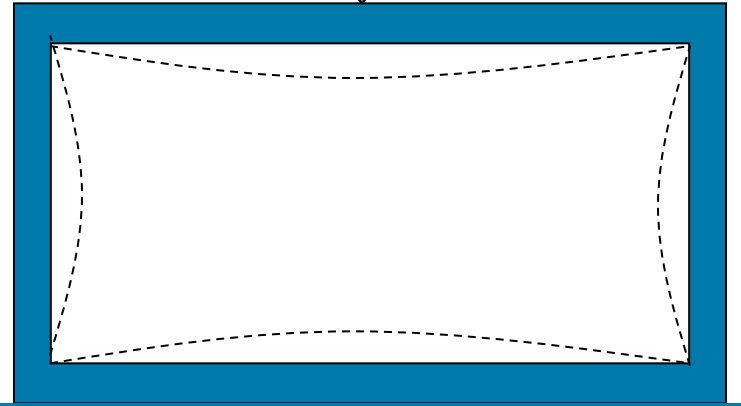

Stiffer

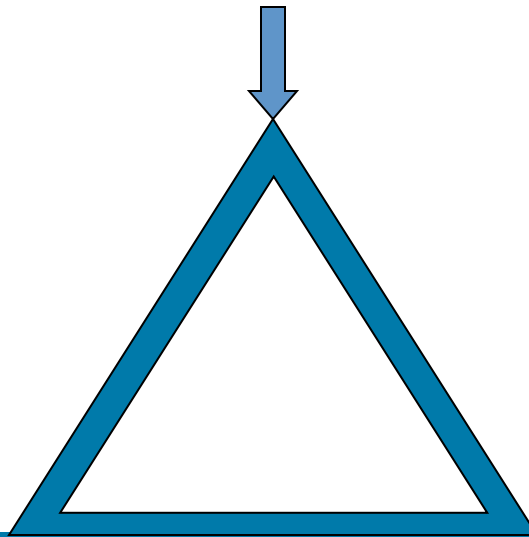

Stiffest

Providing Stability for Lateral Loads

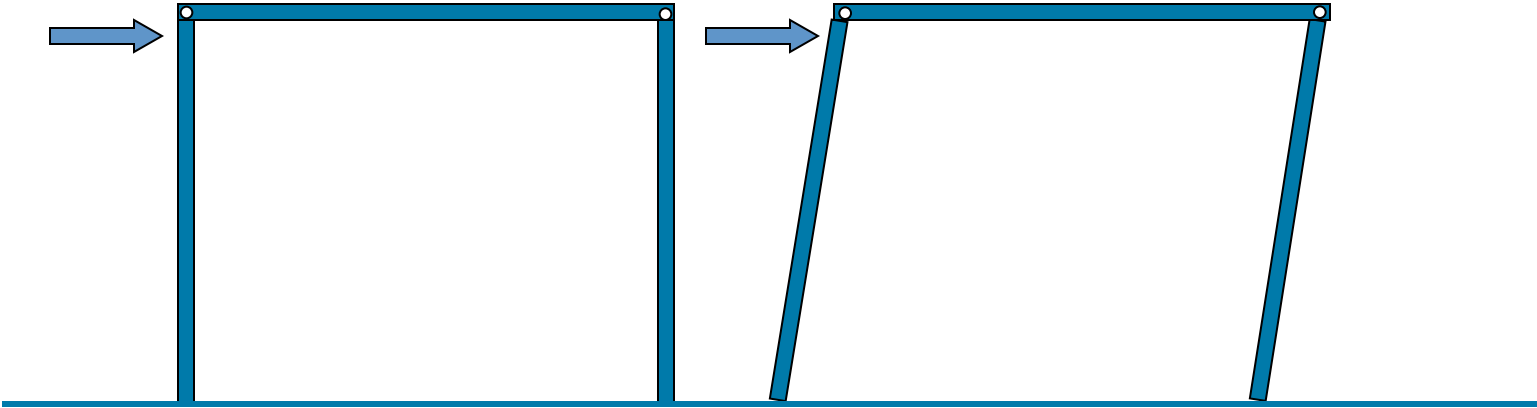

Racking Failure of Pinned Frame



Braced Frame

Infilled Frame

Rigid Joints

Failure Mechanisms

Structural failure refers to **loss in the load-carrying capacity** of a component or member within a structure.

Failure is initiated when the material is stressed to the strength limit, thus causing fracture or excessive deformations.

Ultimate failure is usually associated with extreme events. The structural engineer needs to **prevent loss of life** by prohibiting total collapse of the structural system.

Failure due to Dynamic Instability

Failure to understand aeroelastic flutter can be catastrophic.



Failure of the Tacoma Narrows bridge completely changed the way in which suspension bridges are analyzed and designed.

Failure due to neglect ...



Collapsed I35 W. Mississippi Bridge, August 1, 2007.

Key problems: lack of funding; poor maintenance.

Failure due to lack of Ductility in Concrete Columns



Frame buildings can have also be built with concrete columns and beams (as opposed to steel)

1971 San Fernando earthquake showed that many concrete frames were brittle

Potential for collapse at drifts of about 0.01 (lower than for steel buildings)

There are thousands of these buildings in California and occupants have not been notified

Olive View Hospital
M 6.7 1971 San Fernando Earthquake

Northridge 118 FWY



Example of failure of a brittle concrete column (pre-1975 code)



Example of “ductile” behavior of concrete columns. Although the parking structure performed poorly, the exterior columns did not fail.

Mexico City Earthquake, 1996



CUREe

11 years ago... Mexico Earthquake, September 19, 21-story building collapsed onto 14-story neighbor, Pino Suarez complex *photo credit: Henry Deenkolb*

1996

Failure due to liquefaction



CUREe

35 years ago...Niigata, Japan Earthquake, June 16, 1964: Liquefaction and resulting overturning of buildings at the site of an apartment complex in Niigata.

photo by Joseph Penzien, Steinbrugge Collection/National Information Service for Earthquake Engineering

1999

Sometimes you are simply in the wrong place at the wrong time ...



Christchurch, New Zealand, 2011.

Richter Magnitude = 6.3

Failure of the Christchurch Cathedral...



Sometimes extreme events allow for real innovation!

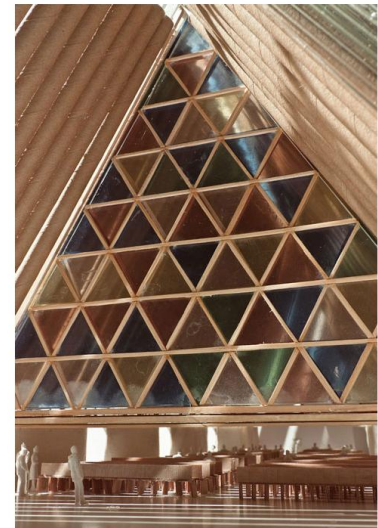

Update for 2016



Richter Magnitude = 7.8



Summary

- Structural Engineering:
 - Identifies loads to be resisted
 - Identifies alternatives for providing load paths (arch, truss, frame, ...)
 - Designs structure to provide safe and economical load paths (material, size, connections)
 - To be economical and safe, **we must be able to predict what forces are in structure.**

Acknowledgement: University of Massachusetts Amherst